



JHY ROBOT

Control System Instructions

V1.0



Wuxi Jihoyen Industrial Automation Co., Ltd.

Contents

1. Terms and Definitions	1
1.1 Teach pendant	1
1.2 Key Indication	1
2 Security	2
2.1 Safety Norm	2
2.2 Safety Precautions for Operators	3
2.3 Safety Precautions During Operation	4
3 Assembly Line	10
3.1 Installation Site and Environment	10
3.2 Installation Wiring Precautions	11
3.3 Power Supply	16
4 Teach Pendant	18
4.1 teach pendant Key Function	19
4.2 Main Interface	22
4.3 System Application Menu	24
4.4 Status Bar	28
4.5 Floating Menu	30
4.6 Robot Status and Alarm History View	31
5 Quick Start	34
5.1 Servo Power On	34
5.2 Servo Power Off	36
5.3 Choice of Coordinate System	37
5.4 Manual Speed Adjustment	37
5.5 Axis Operation	37
6 Coordinate System	39
6.1 Coordinate System Description	39

6.2 Coordinate System Management Interface41

6.3 Articular Coordinate System(ACS) 42

6.4 Robot Coordinate System (KCS)42

6.5 Tool Coordinate System43

6.6 Workpiece Coordinate System(PCS)52

6.7 World Coordinate System58

7 System Parameter 59

7.1 System Parameters 59

7.2 Hardware Parameters 61

7.3 Joint (Physiology) 63

7.4 Auxiliary Shaft 65

7.5 Descartes 66

7.6 Planning Parameters68

7.7 DH Parameters 72

7.8 Coupling 73

8 General IO 74

8.1 Input Signal 74

8.2 Output Signal 76

8.3 IO Wiring 78

9 Other Functions79

9.1 Home Point Calibration 79

9.2 The 20-Point Method 82

9.3 Exception Handling83

9.4 Permissions Management 84

1. Terms and Definitions

The following terms and definitions apply to this document.

1.1 Teach pendant

A handheld unit that can be used to program or move a robot and is connected to a control system.

1.2 Key Indication

1. The keys on the hand-held operation teach pendant are indicated by []: for example, the emergency stop key is represented by the [Emergency Stop] key.
2. The keys on the display screen are represented by {}: for example, the clear key is represented by the {clear}key

2 Security

2.1 Safety Norm

Requirements for robots are usually different from those of other mechanical equipment, such as large motion range, fast operation, and rapid movements of the robot arm, all of which can cause safety hazards.

Read and understand the instruction manuals and related documents, and follow various rules and procedures to avoid personal injury or equipment accidents. It is the user's responsibility to ensure that the robot system is always operated in a safe operating environment and to comply with and observe national and local laws, regulations and related ordinances regarding safety.

Compliance with legislation and regulations



The following regulations must be followed for the maintenance of the robot's teaching

1. Laws relating to industrial safety and health.
2. Mandatory orders on industrial safety and health laws.
3. The corresponding regulations on industrial safety and health laws.
4. Safe operation of industrial robots (ISO 10218).

The teaching and maintenance work of robots is listed as a "**hazardous operation**" in industrial safety and health legislation.

Security Management



1. The person who teach and maintain the robot must be trained in advance.

Safety management is carried out according to specific policies in compliance with relevant regulations. Designate authorized operators and safety management person, and give a further safety train .

2.2 Safety Precautions for Operators

There is a potential danger within the maximum motion range of the robot.

Safety first must be established at all times for all relevant personnel in the robotics industry (safety managers, installers, operators, maintenance personnel, etc.), and relevant operations must be carried out on the premise of ensuring the safety of all personnel.

1. Any dangerous operation is prohibited in the installation area of the robot.
2. The following provisions are strictly observed in the operational area.
 - Wear work clothes (no loose clothes).
 - No gloves are allowed to be worn when operating the robot.
 - Underwear, shirts and ties should not be exposed from within the work clothes.
 - No jewelry, such as earrings, rings or pendants.
 - Wear appropriate safety equipment such as safety helmets, safety shoes (with non-slip soles), face shields, protective goggles and gloves when necessary.
3. Unauthorized personnel are not allowed to approach the robot and its peripheral auxiliary equipment.
4. During the operation of the equipment, the robot appears to have stopped, it may also be because the robot is waiting for a start signal and is about to move. Even in such a state, the robot should be considered to be in motion. To ensure the safety of the operator, the robot should be able to be displayed with an alarm light or sound to inform the operator that the robot is in motion.
5. Never forcefully wrench the robot's axes as this may cause personal injury or equipment damage.
6. Never lean on the robot's electrical control cabinet; do not press the operation keys arbitrarily. Otherwise it may cause the robot to produce unexpected movements, resulting in personal injury and equipment damage.
7. Non-worker is not allowed to touch the robot's electrical control cabinet during operation. Otherwise it may cause the robot to produce unexpected movements, which may result in personal injury or equipment damage.

2.3 Safety Precautions During Operation

2.3.1 General Principle

To operate the robot system safely, follow these guidelines below:

1. If there is a worker in the protected space, operate the robot system manually. When entering the protected space, be sure to carry the control device with you so that you can control the robot at all times.
2. Watch out for rotating or moving tools, such as cutting tools and saws. Make sure that these tools have stopped moving before approaching the robot.
3. Watch out the high temperature surfaces of the workpiece and robot system. Robot motors can be very hot after long periods of operation.
4. Pay attention to the clamps and make sure the workpiece is clamped. If the clamp is open, the workpiece can fall off and cause personal injury or equipment damage. The clamps are very powerful and can also cause personal injury if not handled correctly.
5. Watch out for hydraulic and pneumatic systems and electrically charged components. Even with a power outage, residual power on these circuits can be dangerous.
6. When attaching a tool to the robot, be sure to turn off the power to the control cabinet and the installed tools, lock the power switch and hang a warning sign. If the power is turned on during installation and maintenance, for example, it may cause electric shock or cause the robot to move abnormally, which may cause injury.
7. Never exceed the permissible range of the robot (see the technical specifications section in the robot manual for the permissible range of the robot). Failure to do so may result in personal injury or equipment damage.
8. Whenever possible, teaching work should be carried out outside the operating area.
9. When teaching work is performed within the robot's motion range, the following warnings should be observed:
10. Always observe from the front of the robot.
 - Always follow pre-established operating procedures.

Simulate the solution to avoid when the robot has an unexpected action to ensure that it has a retreat in an emergency.

2.3.2 Emergency Treatment



The emergency stop button should be pressed immediately when:

1. Maneuvering the robot in such a way that there are obstacles in the robot's operating space where collisions may occur, or other personnel in the operating space.
2. Robots hurt people or machinery.

2.3.3 Operating the Handheld teach pendant

2.3.3.1 Operating the handheld teach pendant

1. **The Handheld is a high quality handheld terminal equipped with highly sensitive and advanced electronics. To avoid malfunction or damage caused by improper operation, please follow the instructions below when operating.**
2. **The handheld teach pendant is to be used only for the purposes specified in this manual. The handheld teach pendant has been developed, manufactured and tested in accordance with the applicable safety standards. If you follow the instructions for safety and use in this manual, the product will neither cause personal injury nor damage to machinery and equipment under normal conditions.**

2.3.3.2 Handling and Cleaning

1. **Handle with care. Do not drop, throw or hit hard. This can cause breakage or malfunction.**
2. **In the event of a shock, be sure to verify and confirm that the safety features (actuators and emergency stop) are working properly and are not damaged.**
3. **When the unit is not in use, store it on a vertical wall shelf to prevent accidental falling off.**
4. **Always make sure the cable does not trip over a person when using and storing the handheld teach pendant.**
5. **Do not use sharp objects (such as screwdrivers or pen tips) to operate the touch screen. This may make the touch screen damaged. Use your finger or a stylus (depending on the model, some models of the teach pendant do not come with a stylus and are generally located on the back of the teach pendant with**

the handheld).

6. **Clean the touch screen regularly. Dust and small particles may get in the way of the touch screen causing malfunctions.**
7. **Do not use solvents, detergents or scrubbing sponges to clean the handheld teach pendant. Use a soft cloth with a small amount of water or neutral detergent to clean.**
8. **Be sure to close the protective cover of the USB port when no USB device is connected. If the port is exposed to dust, then it will be interrupted or malfunction.**

2.3.3.3 Cables and Power Supplies

1. **Turn off the power before opening the cable entry area of the handheld teach pendant. Otherwise the components may be damaged, or an unknown signal may appear.**
2. **Make sure that no one is trapped by the cable so that the device does not fall to the ground.**
3. **Avoid crushing by other objects to avoid damage to the cable.**
4. **Do not place the cable over sharp edges to avoid damaging the cable jacket.**

2.3.4 Security Tools

2.3.4.1 Security Protection Mechanisms

Robot systems can be equipped with a variety of safety protection devices, such as door interlock switches, safety light curtains and safety mats, etc. The most commonly used is the door interlock switch of the robot cell, which can be opened to pause the robot. When using it, the customer needs to configure the corresponding switch signal in the robot control system, and map the I/O port connected to the hardware to the dedicated signal. Please refer to the contents of I/O settings in this manual.

2.3.4.2 Security Monitoring

Emergency stops and safety guards are monitored so that the controller can detect any faults and the robot will stop until the problem is resolved.

2.3.4.3 Built-in Safety Stop Function

The controller continuously monitors hardware and software functions. If any problems or errors are detected, the robot will stop operating until the problem is resolved.

2.3.4.4 Limiting the Range of Robot Work

The robot operating range can be limited by mechanical stops, software functions, or a combination of both. Please refer to the documentation related to the functions in this manual for instructions on how to configure the robot system.

2.3.5 Safety Matters in Manual Mode

2.3.5.1 Introduction to Manual Mode

In manual mode, the movement of the robot is under manual control. A three-position enabler must be pressed to start the robot's motor, i.e. to allow movement.

The manual mode is suitable for use in creating and verifying programs and debugging manipulator systems.

2.3.5.2 Operation speed

1. In manual deceleration mode, the movement of the manipulator is limited to 250 mm/s (you can set whether this function is enabled or not via the setting function).
2. When operating the manipulator in manual mode, the operator is very close to the manipulator. Manipulating industrial manipulators can be hazardous and should therefore be done in a controlled manner.
3. In manual mode, the manipulator moves at a preset speed, but must be under manual control. Manual mode should only be used when all personnel are located outside the safe protected space and the operator must be specially trained and aware of the potential hazards.

2.3.5.3 Three-position enabling device

1. In manual mode, the robot's motors are activated by the three-position enabling device on the handheld teach pendant. In this way, the robot can only move if the enabling device is pressed.
2. This "stop-motion" function also works when stepping through the program in manual full speed mode.
3. The three-position enabling device is uniquely designed so that you must press the button halfway down to start the robot motor. If the button is not pressed or fully pressed, the robot will not move.

2.3.6 Safety matters in automatic mode

2.3.6.1 Introduction to Automatic Mode

1. Automatic mode is used to run the robot program in production.
2. In automatic mode the safety function of the three-position enabling device is deactivated to allow the robot to move without manual intervention.

2.3.6.2 Process interference

1. **Process disturbances can affect not only specific manipulator units, but also the entire system chain, even if the problem is caused by a specific unit.**
2. **The chain of events may result in dangerous operations not being known when operating individual manipulator units, so special attention must be paid to this interference. The person performing all remedial measures must be familiar with the entire production line, not just the malfunctioning manipulator.**

3 Assembly Line

3.1 Installation Site and Environment

3.1.1 Installation Environment Requirements

The following conditions must be met at the installation site prior to the installation of the **electrical control cabinet**.

1. (a) The ambient temperature during operation shall be between 0° and 45° C (32° and 113° F).
2. (a) -10° to 60°C (14° to 140°F) during handling and maintenance.
3. (a) The humidity must be below the dew point (below 10 per cent relative humidity).
4. Sites with low levels of dust, fumes, grease and water.
5. (a) Flammable materials and corrosive liquids and gases are not allowed in the work area.
6. For electric control cabinets where vibration or shock energy is small (vibration below 0.5G); .
7. There should be no large electrical noise sources (e.g. gas shielded welding (TIG) equipment, etc.) in the vicinity.
8. There is no potential danger of collision with mobile equipment (e.g. forklift).

3.1.2 Installation Location Requirements

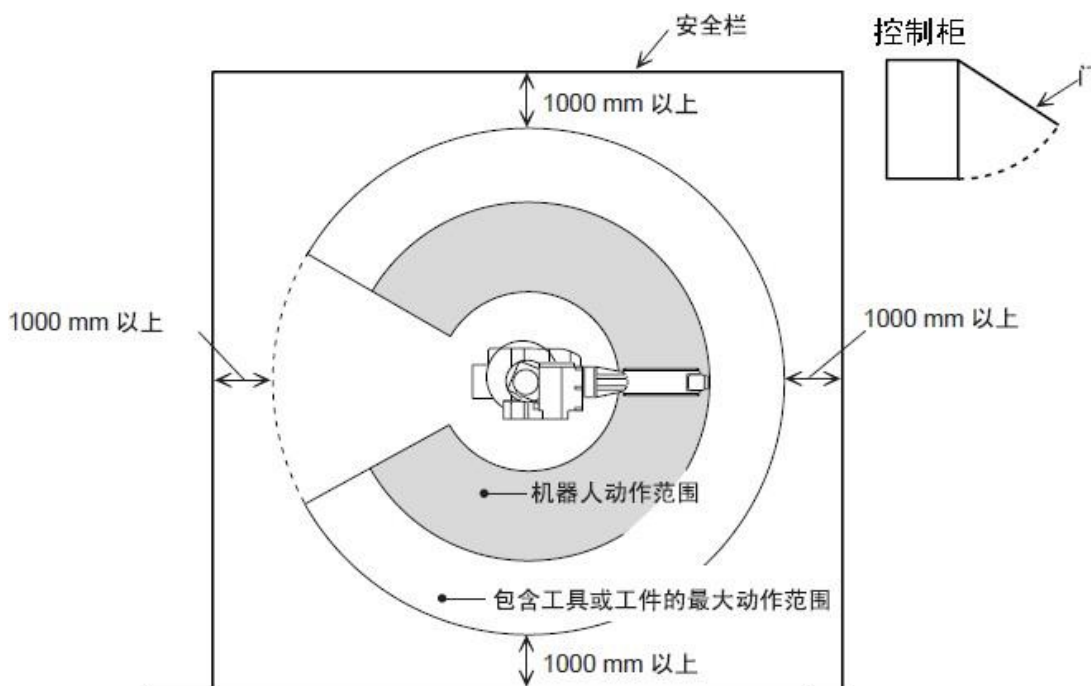

Figure 1 Installation Location Requirements

-
1. The **electrical control cabinet** should be installed outside the robot's range of motion (outside the safety bar).
 2. The **electrical control cabinet** should be installed in a location where the robot's movements can be seen.
 3. The **electrical control cabinet should be** installed in a location where the door can be easily opened for inspection.
 4. Install the **electrical control cabinet** at least 500mm from the wall to keep maintenance access clear.

3.2 Installation Wiring Precautions



1. The system must be electrically grounded. Failure to ground the equipment could result in fire or electric shock, which could cause personal injury.
2. Before grounding the system, turn off the power and lock out the main power switch. Failure to do so may result in electric shock and personal injury.
3. Do not touch any substrate in the cabinet for 5 minutes after the power is cut off. Capacitors store electrical energy after the power is cut off, so be careful whenever handling the baseboard, failure to observe this warning may result in electric shock.
4. The power cannot be opened if the door is not closed, i.e. the safety interlocking device prevents the power from being opened. Failure to do so may result in fire or electric shock.
5. During wiring, the electrical cabinet is in the emergency stop mode and anything that happens is the responsibility of the user. An operational check is required once wiring is complete. Failure to do so may result in personal injury or mechanical failure.



6. Do not climb on top of the electrical cabinet. Failure to do so may result in personal injury or mechanical failure.
7. Wiring shall be performed by authorized personnel. Improper wiring may cause fire or electric shock.
8. Wiring should be done in accordance with the rated capacity specified in the instructions. Incorrect wiring may cause fire or mechanical damage.
9. Verify that each circuit is safely and securely wired. Poorly wired circuits can cause a fire or electric shock.
10. Do not touch the substrate directly with your hands. Integrated circuit (IC) substrates may malfunction due to static electricity.

3.2.1 Controller Interface



Figure 2 Controller Interface

Interface Name	instructions
24V terminal (must be connected)	Power supply to 24V
TP (connect to teach pendant) (always connect)	The other end is connected to the handheld box network port, default IP: 192.168.100.3
Ecat (be sure to connect)	and ecat drive cable connection (standard network cable interface)
LAN1 (optional)	Default IP: 192.168.101.3
LAN2 (optional)	Default IP: 192.168.102.3
LAN3 (optional)	Default IP: 192.168.103.3
RS232/CAN/485 combination port (optional)	For external communication
USB2.0/USB3.0 (optional)	External USB keyboard and mouse or USB flash drive
HDMI (optional)	External HDMI interface monitor

RS-232/485/CAN interface header definition

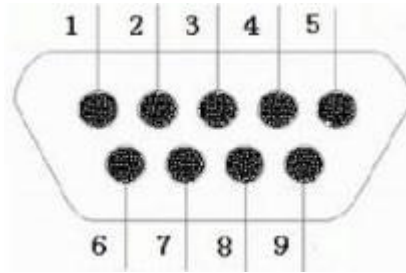

1	VCCS_CAN	CAN power supply 24V
2	RS232_RX	Serial 232 communication reception
3	CAN_L	CAN low level
4	RS485-	Serial port 485 communication low level
5	GND	earth (electric connection)
6	CAN_GND	CAN Grounding
7	RS232_TX	Serial 232 communication send
8	CAN_H	CAN high level
9	RS485+	Serial port 485 communication high level

3.2.2 Controller Status Indicator Description

Status Indicator HD.

Displays the read and write status of the drive. If the status indicator is on, it indicates that a drive write operation is in progress. This status indicator is controlled by the controller's hardware system and is not subject to upper-level program operation.

Status indicator RUN.

The status indicator RUN stays on after power-up (EtherCAT driver is not loaded). When the EtherCAT driver is started, the driver will control this status indicator. The status indicator RUN under EtherCAT driver operation shows the following status.

1. Driver in idle state (waiting for application to request master): 1s on + 1 sec off, alternating, i.e. slow flash
2. Bus communication disconnection: 300ms on + 200ms off + 300ms on + 1200ms off, alternating, i.e. 2 flashes
3. The application requests the master to enter OP mode (PDO interactive communication): 100ms on + 100ms off, alternating, i.e. flashing

Status Indicator EC.

The status indicator EC remains on after power-up and is operated automatically when the EtherCAT interface program is started, in automatic mode

1. System not registered: 200ms on + 200ms off + 800ms on + 800ms off, alternately, i.e. fast flashing + slow flashing
2. Network disconnection or NIC status abnormality: 200ms on + 200ms off + 200ms on + 1400ms off, alternately, i.e. flashing 2 times
3. Master requesting busy (master is scanning slave): 1s on + 1 sec off, alternating, i.e. slow flash
4. Master Ready (PDO communication established): 100ms on + 100ms off, alternating, i.e. flashing

5. Other status (during master configuration): 200ms on + 200ms off + 200ms on + 200ms off + 200ms on + 1000ms off, alternately, i.e., after 3 application exit flashes, the status indicator ERR is displayed indefinitely and may be always on or always off.

3.2.3 teach pendant Mounting Wiring

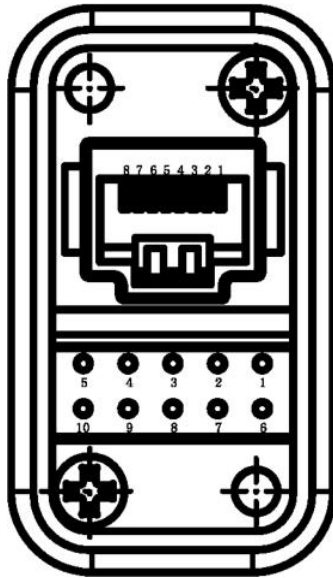

Figure 3teach pendant Aerial Plug

teach pendant external cable definition.

1	bonus	24V+	Connect 24V power supply +
2	white red	0V	Connect 24V power supply 0V
3	dark	PE	earth (electric connection)
4	green	EMG1-1	Emergency stop terminal 1
5	dark green	EMG1-2	Emergency stop terminal 1
6	indigo plant	EMG2-1	Emergency stop terminal 2
7	Black and Blue	EMG2-2	Emergency stop terminal 2

(specific by line number)

The handheld box must be connected to 24V power supply wiring, the emergency stop terminal can be used as needed, the emergency stop terminal provides two sets of wiring outputs, connected to the handheld teach pendant emergency stop signal, the default is normally closed, press the handheld teach pendant emergency stop button to open.

3.3 Power Supply

3.3.1 three-phase power supply

The three-phase power supply is composed of 200V AC, 50Hz or 220V AC, 50/60Hz.

When there is a temporary power supply frequency interruption or voltage drop, the power failure processing circuit will generate an action to cut off the servo power.

Connect the electrical cabinet power supply to a stable input power source with low voltage fluctuations.

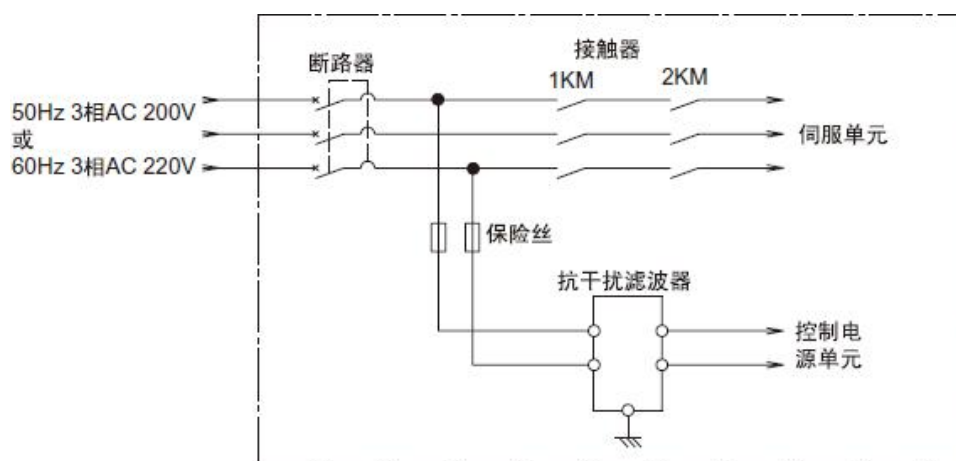

Figure 4 Input connections for power supply

3.3.2 Installation of noise filters

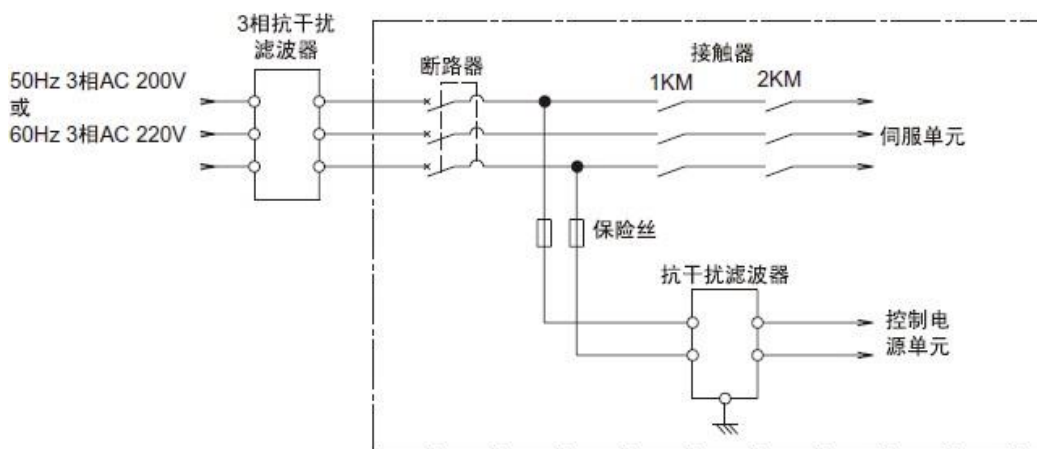

Figure 5 Connection of the three-phase noise filter

3.3.3 Installation of Earth Leakage Circuit Breakers

If a leakage circuit breaker is connected to the power supply of **the electric control cabinet**, a leakage circuit breaker that prevents high frequency leakage current from the rectifier needs to be used, which prevents false operation caused by high frequency leakage current.

Even with the earth leakage circuit breaker installed, there is still the possibility of high frequency current leakage from the rectifier of the NX100, but such current leakage is not dangerous.

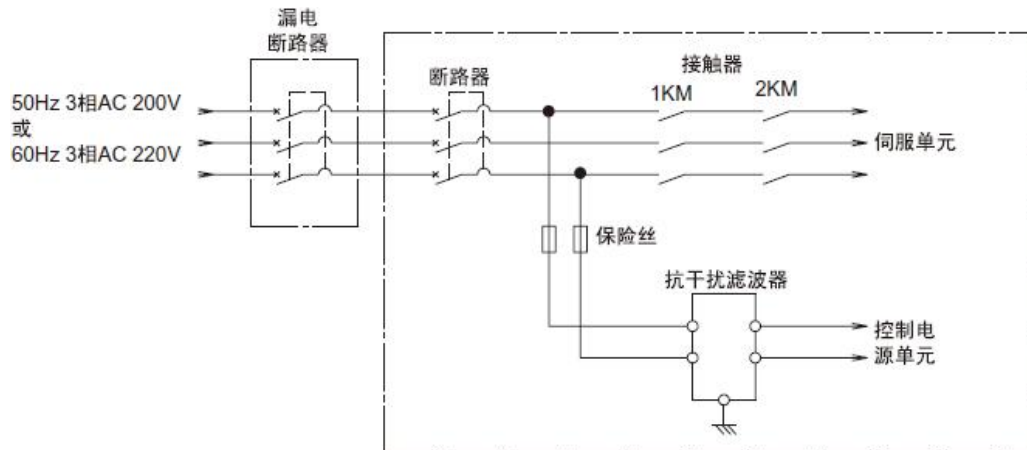





Figure 6 Connection of Earth Leakage Circuit Breaker





4 Teach Pendant







This chapter describes the robot handheld operation teach pendant layout and button functions.



4.1 teach pendant Key Function

Serial number	name (of a thing)	button or key (on a device)	functionalities
1	emergency stop		<p>Press this button to cut off the servo power.</p> <p>When the servo power is cut off, the [Servo Ready Indicator] of the handheld operation teach pendant goes out and the emergency stop message is displayed on the screen.</p> <p>After troubleshooting, the emergency stop button can be opened and the emergency stop knob opened before the servo power can continue to be turned on.</p> <p>This key will not turn on the servo power when pressed.</p> <p>How to open the emergency stop button: Turn clockwise until the emergency stop button pops up, accompanied by a "click" sound, which means the [emergency stop button] is open.</p>
2	pause (media player)		<p>Press this button to pause the robot.</p> <p>This key can be used in any mode.</p> <p>In Demonstration Mode: This light comes on when pressed, and the robot cannot perform axis operations at this time.</p> <p>In playback mode: this button indicator can be pressed once to enter pause mode, when the pause indicator lights up and the robot is in pause. Press the [Start] button on the handheld operation teach pendant to make the robot continue working.</p>
3	launch		<p>Press this button and the robot starts playback operation.</p> <p>This indicator lights up during playback mode operation.</p> <p>This indicator lights up when the robot starts playback operation by the start signal of the dedicated input.</p> <p>The mode knob must be set to playback mode before pressing this button; make sure the Handheld Operation teach pendant [Servo Ready] indicator is lit.</p>
4	Mode knob		<p>Selectable playback mode, demonstration mode or remote mode.</p> <p>TEACH (Teaching and Learning): Demonstration mode</p> <p>Axis operation and editing can be performed with the handheld operation teach pendant (in this mode, operating signals from external devices are not valid).</p>

			<p>Playback (PLAY): Playback mode The program can be played back and run after the demonstration.</p> <p>Remote (REMOTE): Remote mode Start-up of the demonstration program can be operated via external TCP/IP protocol, IO.</p>
5	Three-section switch		<p>Press this button to turn the servo power on.</p> <p>The mode knob must be set in the demonstration mode before operation → Click the [Servo Ready] key on the hand-held operation teach pendant ([Servo Ready] indicator is in flashing state) → Gently hold the three- section switch and the servo power is turned on ([Servo Ready] indicator is in constant light). If you hold it hard at this time, the servo power will be cut off.</p> <p>If you do not press the [Servo Ready] button on the hand-held operation teach pendant, the servo power will not turn on even if you gently hold the [Three-Section Switch].</p>
6	hand pulse knob		<p>The scroll wheel rotates up and down to toggle the drop-down box contents, project/program and program line, and press down to confirm the selection.</p>
7	Servo preparation		<p>Press this button to turn the servo power on effectively.</p> <p>When the servo power is cut off due to an emergency stop, etc., use this key to effectively turn on the servo power.</p> <p>When this button is pressed in playback mode and remote mode, the [Servo Ready] indicator lights up and the servo power is turned on.</p> <p>When the Demonstration Mode is pressed, the [Servo Ready] indicator flashes, then lightly hold the [Three Segment Switch] on the Handheld Operation teach pendant, and the [Servo Ready] indicator lights up, indicating that the servo power is turned on.</p>
8	top grade		<p>Can be used in conjunction with other keys.</p>







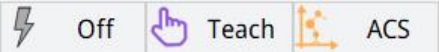

9	menu		<p>Press this key to open the system application menu</p> <p>Programs: program management, file editing Variables: global variable, global position, global increment, engineering variable, engineering position, engineering increment Robot: Coordinate system management, zero calibration, exception handling Settings: Permission management, system parameters Custom: Process</p>
10	interlocking		<p>Auxiliary keys, used in conjunction with other keys.</p> <p>This key must be used in the teach-in mode.</p>
11	Function key 1 Status display		<p>Press this key to open the status display window.</p> <p>View the robot's current position, digital IO, analog, multitasking, speed, variables, workspace, and some process parameters.</p>
12	Function key 2 floating menu		<p>Press this key to open the floating menu</p> <p>The floating menu allows you to switch coordinate systems, switch playback modes, switch robots/variators, switch speeds and part of the process menu.</p>
13	Axis operating keys		<p>The key to operate each axis of the robot.</p> <p>This key set must be used in the teach-in mode.</p> <p>You can press and hold two or more keys to operate multiple axes. The robot operates according to the selected coordinate system and manual speed. Be sure to check that the set coordinate system and speed are appropriate before performing axis operations. Make sure the [Servo Ready] indicator on the robot handheld operation teach pendant is on before operation.</p>
14	advance or retreat		<p>When this key is pressed and held in the servo power-on state, the robot runs in a single step (reverse) of the programmed point trajectory as shown.</p> <p>This key must be used in the teach-in mode.</p>
15	acceleration and deceleration		<p>Setting key for the robot demonstration mode operation speed.</p> <p>The low speed gears are 1%, 2%, 5%, and upwards +/- 5% per key press.</p> <p>The speed being set is displayed in the status bar. [Upshift] + [V+]/[V-] allows you to adjust the playback mode speed.</p>

4.2 Main Interface

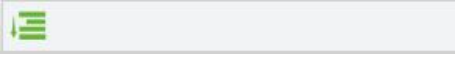
Figure 7 teach pendant Interface



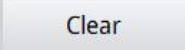

Menu, button, and logo functions in the interface.

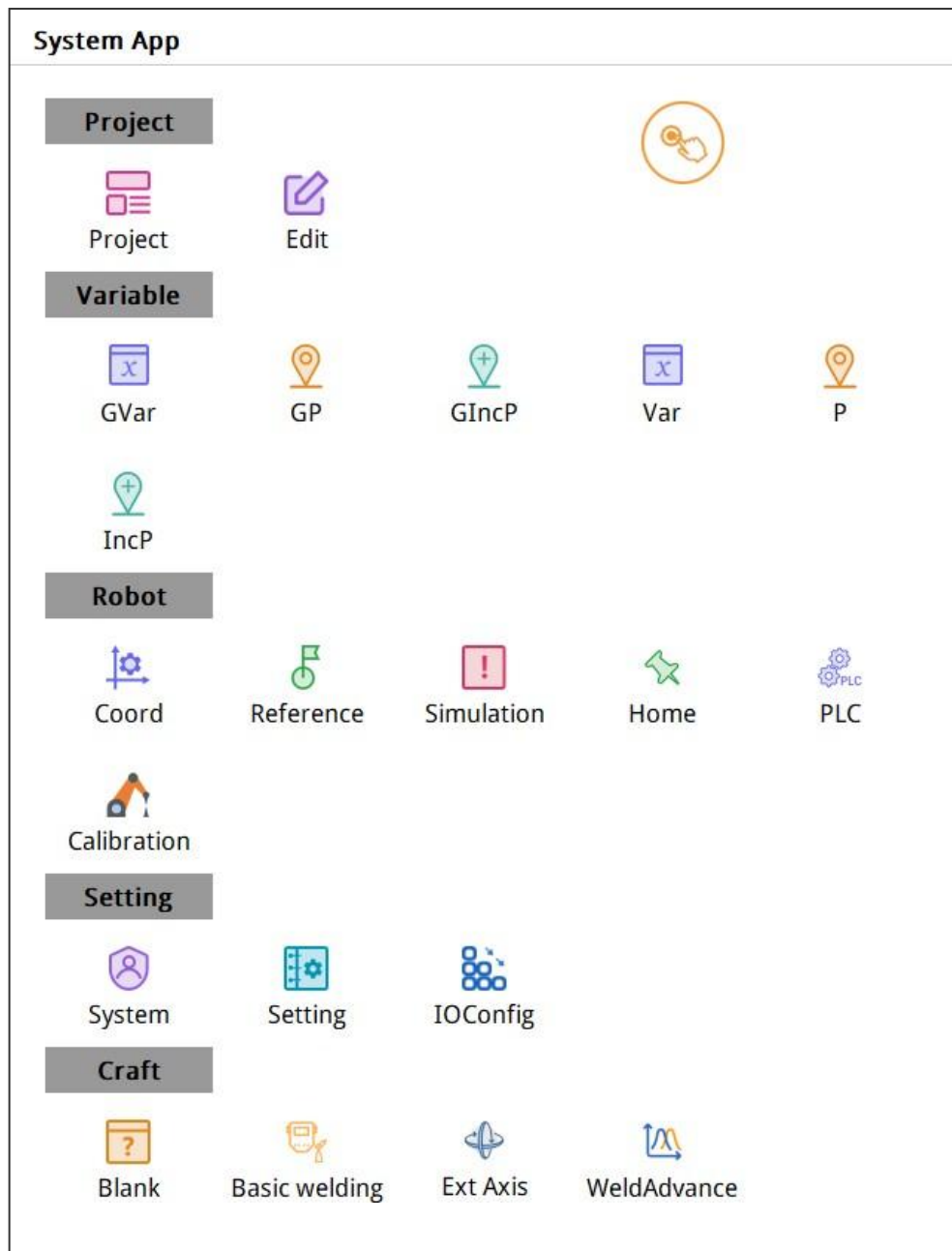

	<p>Each menu and submenu is displayed in the System Applications menu, which is displayed by pressing the [Menu] button on the handheld operation teach pendant, or by clicking the LOGO button in the upper left corner of the interface.</p>
	<p>Displays the current servo, operating mode, and coordinate system status.</p>
	<p>Display of the current tool coordinate system, the serial number of the workpiece coordinate system. Display speed, the former is the speed of the teach-in mode, the latter is the speed of the playback mode</p>
	<p>Displays execution loop mode (loop, single, single step), current project name and program name</p>
	<p>teach pendant connection status, current authority, current coordinate system and other process status</p>
	<p>This button allows you to view the interface log, historical alarm information</p>
	<p>Make error and operation prompts or alarms, no alarm display normal, display movement speed</p>
	<p>Clear the alarm button</p>
	<p>Common Application Toolbar (customizable)</p>

4.3 System Application Menu











4.3.1 Common Toolbar Customization

The system menu bar has two modes of operation, click  or  can switch between each other, in drag mode you can select the commonly used interface icons, by dragging to the common toolbar, easy to quickly switch the interface.

icon (computing)	functionalities	instructions
	click mode	In this mode, click on other small icons in the menu bar to access the corresponding interface
	drag mode	<p>In this mode, dragging allows you to drag small icons from the menu bar to the frequently used applications toolbar</p> <p>Method of operation.</p> <ol style="list-style-type: none"> 1. Switching to dragging mode 2. Press and hold the small icon and drag it to the Common Applications toolbar, release the icon 

4.3.2 Description of menu options

icon (computing)	name (of a thing)	functionalities
	Project Management	<ol style="list-style-type: none"> 1. New construction. 2. Project management: import, export, rename, save as, delete selected projects. 3. (a) New procedure: a new procedure is created under the selected project. 4. Program management: import, export, rename, save as, delete selected programs. 5. Opening procedures.
	Document editing	Editing of the selected program under the current project.
	global variable	Global numeric variables and global strings that can be used in different projects for program editing.
	global position	Positional variables can be calibrated and can be used in different projects for program file editing.
	Global Increment	Positional increments can be written, which can be used in different projects for program file editing.
	Engineering Variables	Project value variables and project strings can only be edited and used in the currently open project
	Project Location	Positional variables can be calibrated and can only be edited for use in the currently open project
	Incremental work	Positional increments can be written, and can only be used for editing under the currently open project

	Coordinate system management	Calibration and modification of the world, tool and workpiece coordinate systems. Set the coordinate system currently in use, the corresponding serial number is displayed in the status bar in the upper right corner of the interface
	Zero point calibration	Calibration of the robot's zero point, manual modification, and absolute encoder zeroing
	Exception handling	Axis Simulation Settings Axis motion limit switch
	HOME Coordinates	Set original position coordinates (back to zero)
	Back-office tasks	Backend task setup, reserved functions
	Permissions management	Set administrator permissions, different permissions exist for different operations. Version Information
	System Parameters	Settings: system parameters, hardware parameters, joints, auxiliary axes, Cartesian, planning parameters, DH parameters
	undefined	Process parameter setting



4.4 Status Bar

4.4.1 Display of servo status

	servo-off
	servo-on

4.4.2 working mode





Displays the robot's operating mode, which is switched by the mode knob on the hand-operated teach pendant.

	Demonstration: The robot is in the demonstration working mode.
	Playback: The robot is in playback working mode.
	Remote: The robot is in remote working mode.

4.4.3 coordinate system

Displays the selected coordinate system, selected via the {coordinate system} of the interface floating menu.

The floating menu is brought up by the [fn2] key on the handheld operation teach pendant.

	joint coordinate system
	Robot coordinate system
	Workpiece coordinate system
	world coordinate system
	Tool coordinate system

4.4.4 Current tool number, part number



It is convenient for the user to determine the serial number of the tool (artifact) currently in use, and the program internally uses a program with 32 elements

of the tool (artifact) coordinate system data queue, with default #1 being no tool (artifact) used and #2 - 32 coordinate system queue elements being editable queue elements.

4.4.5 speed

The current speed is displayed, and acceleration and deceleration are performed by pressing the [V+] or [V-] keys on the hand-held operating teach pendant. The former is the demonstration speed, the latter is the playback speed

4.4.6 Demonstration of teaching file replay execution mode

	(a) Infinite loops: non-stop looping of the teaching procedure.
	(a) Single cycle: the teaching procedure is performed only once.
	Single line run: executes only one teaching procedure at a time.



4.4.7 Current Permissions and Network Status

4.4.7.1 Level of authority

Change in the System Applications menu - Permissions Management



 <p style="text-align: center;">operating mode</p>	 <p style="text-align: center;">management model</p>	 <p style="text-align: center;">Factory Settings</p>
--	--	--

4.4.7.2 network status

 teach pendant Online	 teach pendant offline
--	---

4.5 Floating Menu



The floating menu is popped up/closed by the [fn2] key on the handheld operation teach pendant. Shortcut switching function.

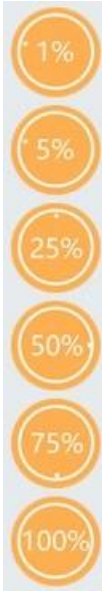

first level	second level	Function description
	 jog coordinate system switching	Switching to an articulated coordinate system
		Switching to the robot coordinate system
		Switching to the workpiece coordinate system
		Switching to the world coordinate system
		Switching to the tool coordinate system
	 Playback program execution mode	infinite loop
		single execution
		one-line execution

	 <p>jog axis switching</p>	<p>Switching to robot axes (Holding [J1] - [J8] at this point represents the robot's axes)</p> <p>Switching to the auxiliary axis (Holding [J1] - [J8] for external auxiliary axis at this time)</p>
	 <p>Speed percentage switch</p>	<p>Percentage of speed to switch the current mode</p>

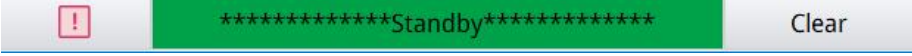
4.6 Robot Status and Alarm History View

4.6.1 Robot Status

statuses	instructions
normal	 <p>The robot is in normal operation, at which time it can operate the servo motion on the robot and execute operations such as schematic programs.</p>
servo (small electric motor) preparations	 <p>Robot is in servo power-up</p>
Under implementation	 <p>The robot is moving or executing a teach-in program, and the number after it indicates the current linear speed of the end of the robot</p>







pornographic warning	  "TCP socket error (Connection timed out)" 清除 <p>The robot is in an alarm state, which does not cause the robot to go down the servo or</p>
----------------------	--

	emergency stop, and requires the operator to check the contents of the alarm to eliminate the cause of the alarm.
red (color) give a warning	 急停按钮被按下 Clear <p>The robot is in a critical alarm state, which causes the robot to stop sharply and go down self-service, and the robot cannot enter servo ready until the alarm is cleared</p>

When there is an error message or alarm, the middle display area turns yellow or red and displays the error alarm message. Press the {Clear} button on the right to clear the error.

4.6.2 Robot alarm history and operation log view

The left button allows you to view the log of all the alarms that have appeared and the interface log (as shown below).

sports event	instructions
Interface log	<p>Record historical interface operations and alarms</p> <div style="border: 1px solid gray; padding: 5px;"> <p style="margin: 0;">Alarm history Ui Log</p> <div style="margin-top: 5px;">  [2021-11-09 18:59:47] "Change page to 13"  [2021-11-09 18:59:38] "File TEST.zszs Modified"  [2021-11-09 18:59:38] "ModifyInstruction"  [2021-11-09 18:56:28] changed work mode : 0  [2021-11-09 18:56:28] "Switch Mode 1->0"  [2021-11-09 18:53:39] changed work mode : 1 </div> <p style="text-align: right; margin-top: 5px;">Delete</p> </div>
give a warning histories	Record system alarm history

Alarm history	Ui Log				
[2021-11-09 18:54:22.655][softplc] 4 50000 急停按钮被按下					
[2021-11-09 18:53:58.207][softplc] 4 50000 急停按钮被按下					
[2021-11-09 18:29:20.580][Executor] 3 30000 系统初始化中 ...(0s)					
[2021-11-09 18:29:20.498][Executor] 3 30000 系统初始化中 ...					
[2021-11-08 21:33:57.756][softplc] 4 50000 急停按钮被按下					
[2021-11-08 21:29:43.689][RobotData] 3 21006 加载工程 失败，不存在					
	Level 1	Level 2	Level 3	Refresh	Delete

5 Quick Start

5.1 Servo Power On



When turning on the main power switch on the upper electric control cabinet, make sure that there are no persons within the robot's range of motion. Ignoring this cue may result in accidental contact with the robot resulting in personal injury. If any problems occur, immediately press the emergency stop button, which is located at the top left of the front door of the electrical cabinet.

5.1.1 Turn on the main power

Turn the main power switch on the side panel of the cabinet to the ON position, at which point the main power is turned on. Press the green servo start button on the electric control cabinet panel.

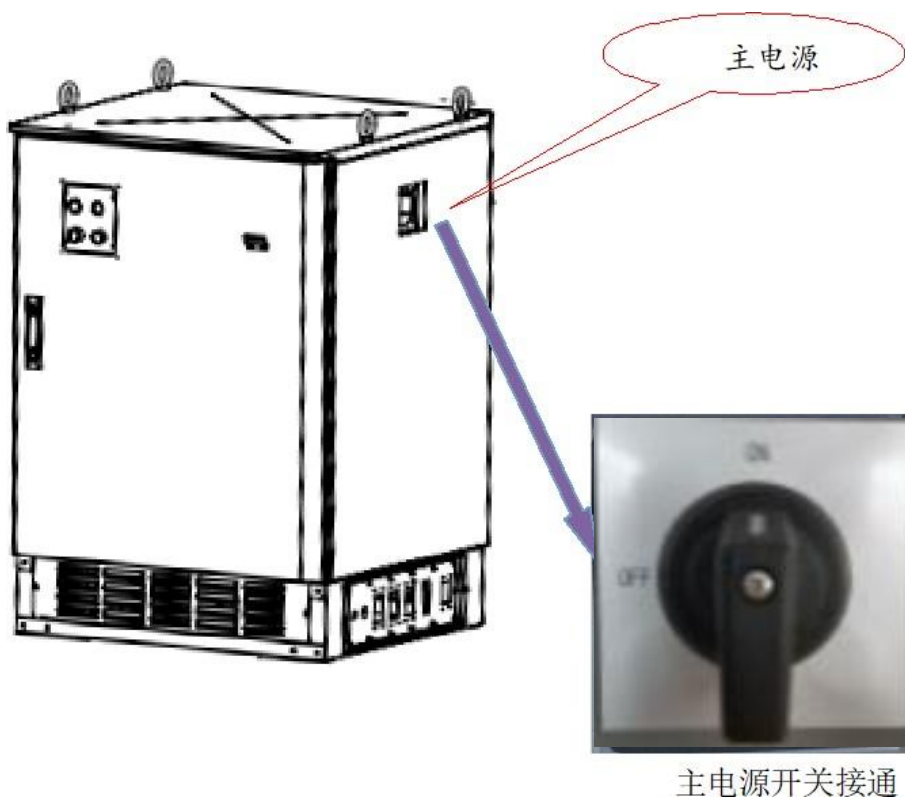

Figure 8 Main Power Switch

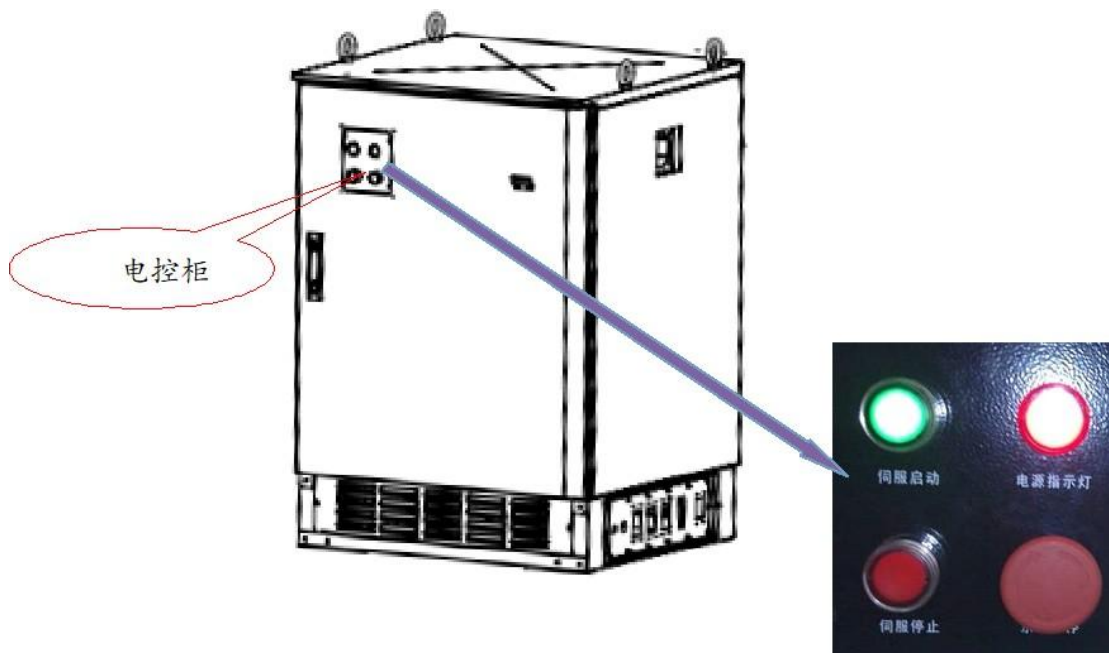

Figure 9 Electrical Control Cabinet Panel

5.1.2 Turn on the servo power

The servo power-on procedure is different for the demonstration mode, playback mode and remote mode.

1. In demonstration mode.

Press the [Servo Ready] button on the hand-held operation teach pendant, then the [Servo Ready] indicator is blinking; gently hold the [Three-Section Switch] on the back of the hand-held operation teach pendant, then the [Servo Ready] indicator on the hand-held operation teach pendant lights up long, indicating that the servo power is on.

2. In replay and remote mode.

Press the [Servo Ready] button on the hand-held operation teach pendant, then the [Servo Ready] indicator on the hand-held operation teach pendant lights up long, indicating that the servo power is on.

5.2 Servo Power Off

5.2.1 Disconnect servo power

The servo power disconnection procedure is different for the **Demonstration mode** and the **Playback and Remote modes**.

1. In demonstration mode.

Release or firmly grip the [Three-Section Switch] on the back of the Handheld Operation teach pendant, at which point the [Servo Ready] indicator on the Handheld Operation teach pendant goes out, indicating that the servo power is cut off.

2. In replay and remote mode

Press the [Servo Ready] button on the handheld operation teach pendant again, at which point the [Servo Ready] indicator on the handheld operation teach pendant goes out, indicating that the servo power is cut off.

3. Press the emergency stop button on the electrical control panel

Once the servo power is cut, the braking device is activated and the robot is braked and can no longer perform any operations.

Emergency Stop can be entered at any time in any mode (Demonstration Mode, Playback Mode or Remote Mode).

5.2.2 Disconnect main power

Cut off the servo power, then cut off the main power.

Turn the main power switch on the side door of the electric control cabinet to the OFF position and the main



power is cut off, as follows.

Figure 10 Rotary Switch

5.3 Choice of Coordinate System

In the teach-in mode, the robot motion coordinate system is selected via the floating menu.

5.4 Manual Speed Adjustment

Modifying the speed of the point-action JOG robot movement in the demonstration mode.

Press the [V+] key or [V-] key on the hand-held operating teach pendant, each time, manual speed +/- 5, confirmed by the speed display in the upper right corner of the status area. (The first value is the teach-in speed)

5.5 Axis Operation

In the teach mode, pressing the **axis operation key** moves each axis of the robot to the desired position, and the motion of each axis varies according to the selected coordinate system.

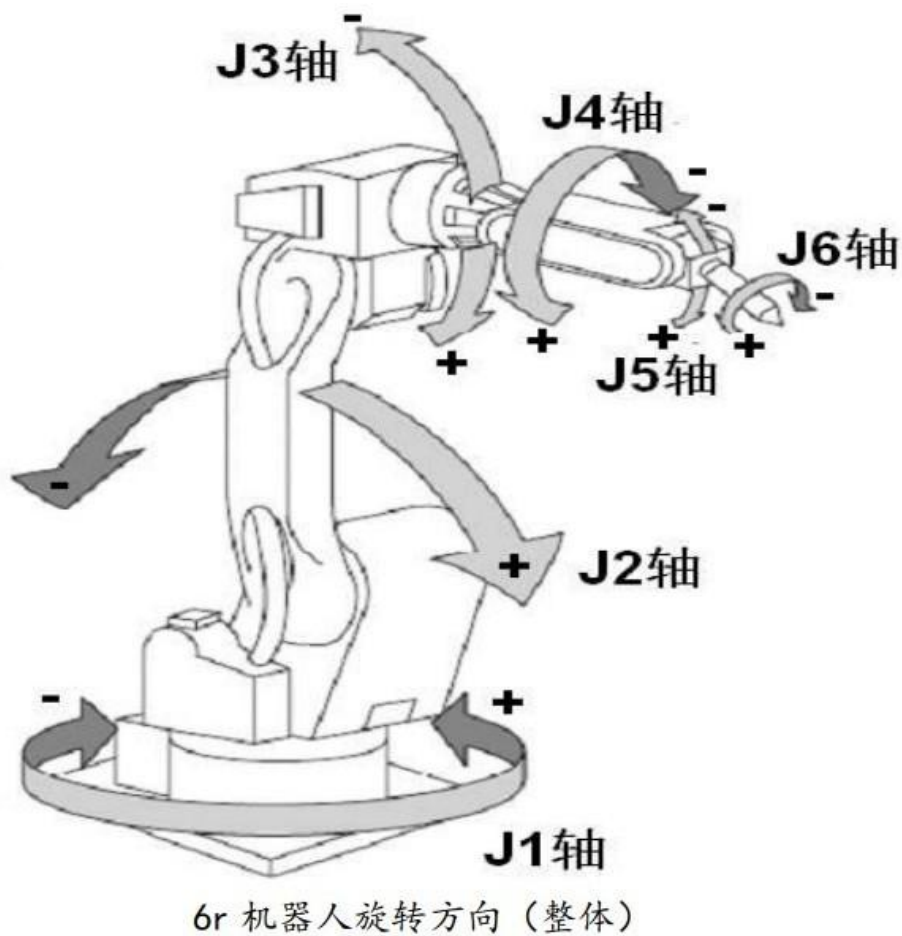

Each axis can only move while the **axis operation key** is held down.



1. Make sure the emergency stop key works properly before operating the robot: press the emergency stop key on the electric control cabinet, and the [Servo Ready] indicator light goes off to indicate that the emergency stop key is normal. If the robot cannot be stopped in an emergency, it may cause damage to the machinery.
2. When working within the robot's range of motion to teach, the following warnings should be observed:
 - Always observe from the front of the robot.
 - Always follow pre-defined operating procedures.
 - Always have an idea of how to evade the robot in the event of an unanticipated movement.
 - Make sure you have a way back for yourself in case of an emergency.

Improper and inattentive operation of the robot can cause injury.

3. Before performing the following operations, confirm that there should be no personnel within the robot's range of motion and that you are in a safe location zone.
 - When power is turned on to the electric control cabinet.
 - When operating the robot with a handheld operator teach pendant.
 - On playback.
 - Remote time.

If the robot collides with any person entering the range of motion, personal injury will result.

4. Perform the following inspection steps before demonstrating the **robot**, correcting any problems immediately and confirming that all other required work has been completed.
 - Checking the movement of the robot for any unusual problems.
 - Check the insulation and coverings of the external cables for damage.

After the servo power is turned on (after pressing the [Servo Ready] key and holding the [Three-Section Switch], the servo indicator is always on), each axis of the robot is made to produce the desired movement by pressing the operation key for each axis on the handheld operation teach pendant. The figure below shows the schematic of the movement of each axis in the joint coordinate system.

Please pay attention to the state of joint movement speed before operating the robot, and adjust it to the appropriate speed by using the high and low speed buttons.

6 Coordinate System

This chapter presents separately the

- ACS - Articulated Coordinate System
- KCS - Robot Coordinate System
- WCS - World Coordinate System
- TCS - Tool Coordinate System
- PCS - workpiece coordinate system

6.1 Coordinate System Description

When performing axis operations on the robot, the following coordinate systems can be used.

6.1.1 Joint Coordinate System - ACS

The Axis Coordinate System (ACS for short) is a purely rotational coordinate system with the mechanical zero point of each axis as the origin. Each joint of the robot can be rotated independently or linked together.

6.1.2 Robot Coordinate System - KCS

Kinematic Coordinate System (KCS for short) is a coordinate system used to model the forward and reverse kinematics of a robot, it is the base Cartesian coordinate system of the robot, it can also be called the Base Coordinate System (BCS) or kinematic coordinate system of the robot. It is the basic Cartesian coordinate system for robots, also known as the Base Coordinate System (BCS) or kinematic coordinate system, in which the TCP at the end of the robot tool can move along the X, Y, and Z axes of the coordinate system and rotate around the X, Y, and Z axes of the coordinate system.

6.1.3 Tool Coordinate System - TCS

Tool Coordinate System, or TCS for short.

Mounting the tool: Use the effective direction of the tool held by the robot's wrist flange as the Z axis of the tool coordinate system, and define the origin of the tool coordinate system at the tool's tip point (or center point) TCP (TOOL CENTER POINT).

No tool installed: At this point the tool coordinate system is established on the center point of the robot flange end face, with the Z-axis direction pointing forward of the flange face perpendicular to the flange end face.

As the robot moves, the tool coordinate system moves with the tool tip point TCP. The user can choose to perform the teach motion under the tool coordinate system TCS. The teach motion under the TCS coordinate system includes the movement motion along the X, Y, and Z axes of the tool coordinate system and the rotation motion around the X, Y, and Z axes of the tool coordinate system axes. The robot system supports 32 custom tool coordinate systems saved by the user.

6.1.4 World Coordinate System - WCS

World Coordinate System (WCS) is also a spatial Cartesian coordinate system. The World Coordinate System is the reference coordinate system for other Cartesian coordinate systems (robot kinematic coordinate system KCS and workpiece coordinate system PCS), and the kinematic coordinate system KCS and workpiece coordinate system PCS are established by referring to the World Coordinate System WCS. In the case that the world coordinate system is not configured by default, there is no position offset or attitude transformation between the world coordinate system and the robot kinematic coordinate system, so the world coordinate system WCS and the robot kinematic coordinate system KCS are coincident at this time. The robot tool end can move along the X, Y and Z axes and rotate around the X, Y and Z axes in the world coordinate system. This robot system supports user to save 32 custom world coordinate systems.

6.1.5 Workpiece coordinate system - PCS

Piece Coordinate System, abbreviated as PCS. the Piece Coordinate System PCS is a Cartesian coordinate system built under the World Coordinate System WCS. The workpiece coordinate system is mainly to facilitate the user to switch multiple identical workpieces under the world coordinate system WCS in one application. In addition, after teaching the workpiece coordinate system, the movement and rotation of the TCP at the end of the robot tool under the workpiece coordinate system can reduce the difficulty of the teaching work. User can save 32 custom workpiece coordinate systems under the workpiece coordinate system.

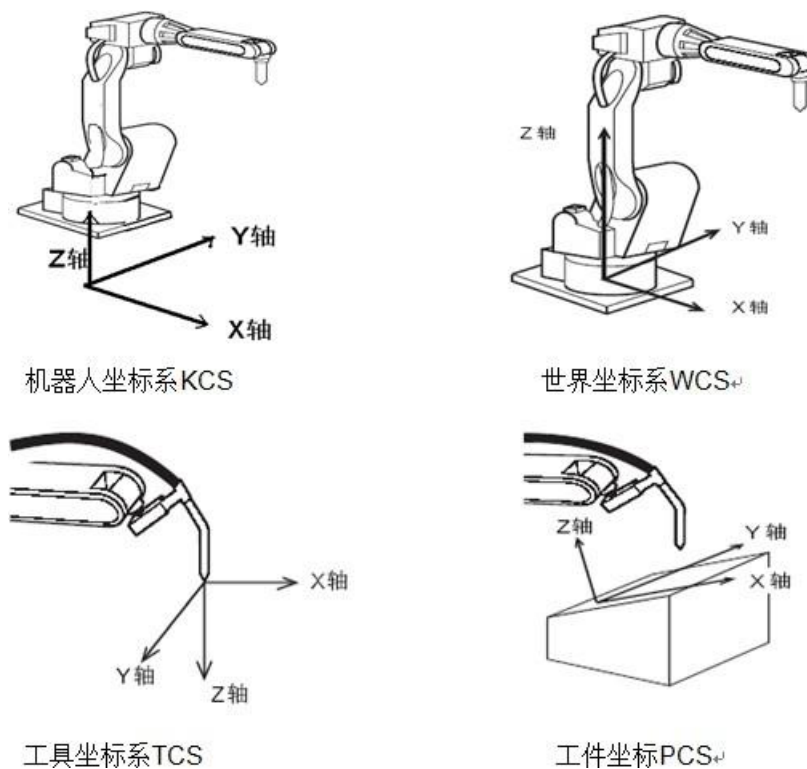

Figure 11 Diagram of the 4 coordinate systems

6.2 Coordinate System Management Interface

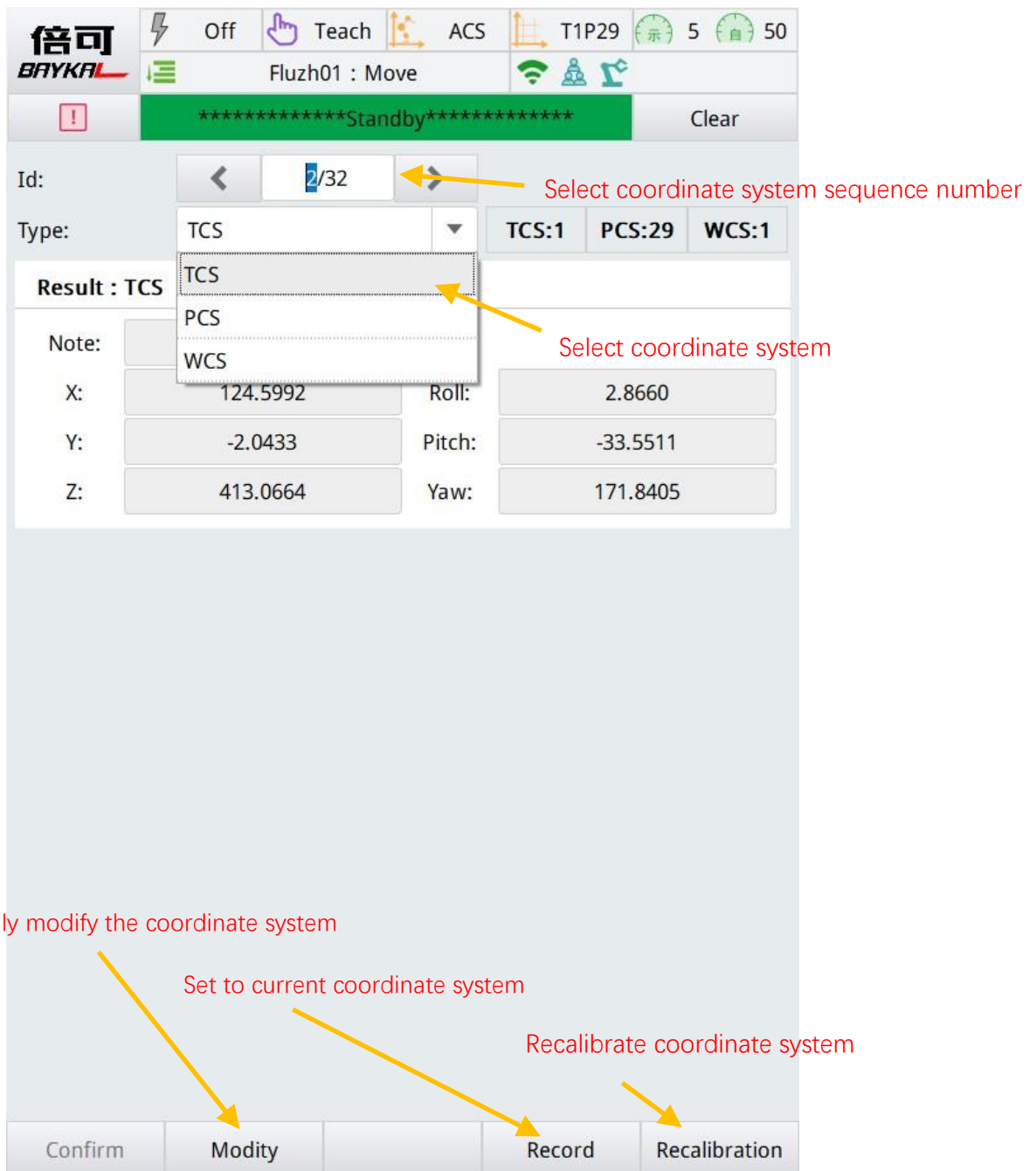



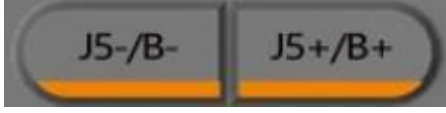
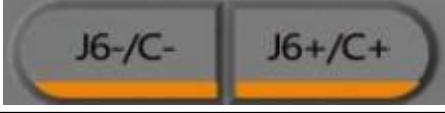

Figure 12Coordinate system interface





6.3 Articular Coordinate System(ACS)



When the coordinate system is set to the articulated coordinate system ACS in the demonstration mode, each axis of the robot J1, J2, J3, J4, J5, and J6 moves separately, and refer to the following table for the movement of each axis when the axis operation key is pressed.

Shaft Name		Axis operating keys	movements
fundamental axis	J1 axis		The body gyrates left and right
	J2 axis		Lower arm back and forth movement
	J3 axis		Upper arm up and down movement
wrist shaft	J4 axis		Upper arm with wrist gyration
	J5 axis		Up and down wrist movement
	J6 axis		wrist gyration

6.4 Robot Coordinate System (KCS)

In the teach mode, when the coordinate system is set to the robot coordinate system KCS, the robot tool end TCP moves in parallel along the X, Y and Z axes of the KCS coordinate system and rotates around the X, Y and Z axes of the KCS coordinate system, refer to the following table for the movements of each axis when the axis operation key is pressed and held.

Shaft Name		Axis operating keys	movements
mobile shaft	X-axis		Translational movement along the X-axis of the KCS coordinate system
	Y-axis		Translational movement along the Y-axis of the KCS coordinate system
	Z-axis		Translational motion along the Z-axis of the KCS coordinate system
	around the X-axis		X-axis rotational motion around KCS coordinates

axis of rotation	around the X-axis		X-axis rotational motion around KCS coordinates
	Around the Y-axis		Y-axis rotational motion around KCS coordinates
	Around the Z-axis		Z-axis rotational motion around KCS coordinates

6.5 Tool Coordinate System

The tool management screen focuses on managing the tools for the robot end flange installation.

6.5.1 Tool coordinate system axis action

The tool coordinate system defines the effective direction of the tool held by the flange of the robot's wrist as the Z-axis and defines the origin of the coordinate system at the tool tip point or center point (TOOL CENTER POINT -- TCP), so the position of the tool coordinate system changes with the movement of the wrist.

Before the tool is specified, the default tool coordinate system is located at the center of the robot flange, as shown in the following figure.

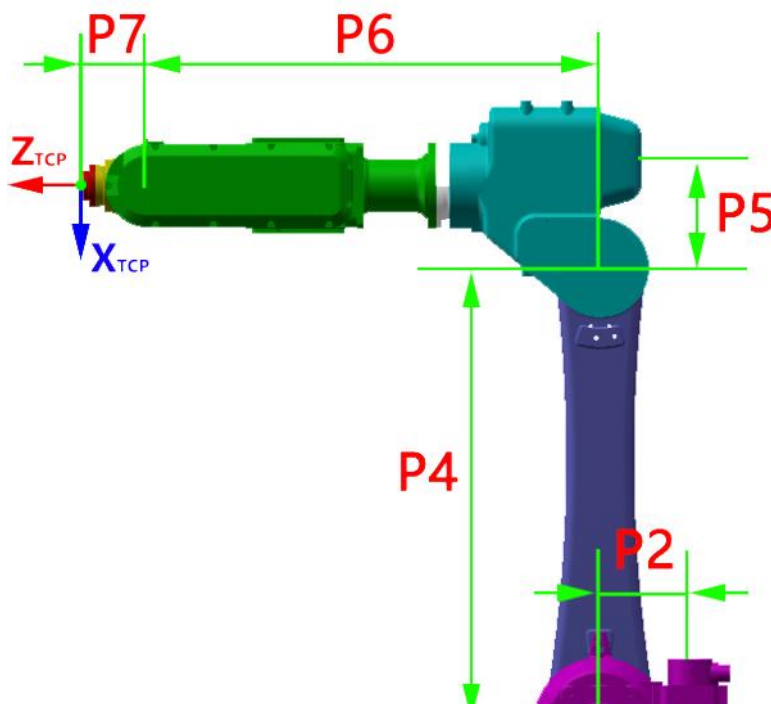







Figure 13 Default Tool Coordinate System

Movement along the tool coordinate system is based on the effective direction of the tool, independent of the robot's position and attitude, so it is most suitable for parallel movement operations that do not change the tool posture relative to the workpiece. Refer to the following table for the movements of each axis.

Shaft Name		Axis operating keys	movements
	X-axis		Translational motion along the X-axis of the TCS coordinate system
	Y-axis		Translational motion along the Y-axis of the TCS coordinate system
	Z-axis		Translational motion along the Z-axis of the TCS coordinate system
axis of rotation	around the X-axis		X-axis rotational motion around TCS coordinates
	Around the Y-axis		Y-axis rotational motion around TCS coordinates
	Around the Z-axis		Z-axis rotational motion around TCS coordinates

6.5.2 Calibration of the tool coordinate system

The user can access this calibration management interface through the submenu {Coordinate System Management} under the System Applications menu. The main interface of Tool Coordinate System TCS management is the same as the main interface of World Coordinate System WCS management.

6.5.2.1 Explanation of parameters

Calibration plane.

XY: The calibration selects three points P1-P3 located in the XY plane, and the Z-axis direction is derived from the X-axis and Y-axis according to the right-hand rule of fork multiplication.

YZ: The calibration selects three points P1-P3 located in the YZ plane, and the X-axis direction is derived from the X-axis and Y-axis according to the right-hand rule of fork multiplication.

ZX: The calibration selects three points P1-P3 located in the ZX plane, and the Y-axis direction is derived from the Z-axis and X-axis by fork multiplication according to the right-hand rule.

6.5.2.2 4-point method: calibration position offset

When using the {4-point method} of calibration, the tip (center) point of the tool to be measured (i.e., the TCP point) is used to approach the same reference point from four arbitrarily different directions, and the reference point can be chosen arbitrarily, but it must be the same fixed and unchanging reference point. The robot controller calculates the TCP from the four different flange positions. the four flange positions from which the robot TCP point moves to the reference point must be spread out enough to make the calculated TCP point as accurate as possible. The {4-point method} is shown schematically as follows.

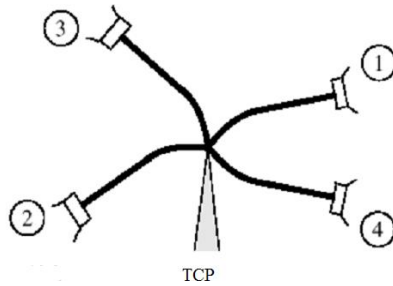

Figure 14 Illustration of the four-point method

{4-point method} Show the steps to teach and calculate the position of the TCP at the centre of the tool as follows.

Step 1: Select the index number of the coordinate system to be refreshed, and select the four-point method demonstration mode.

1. Choose calibration mode

Mode Six-Points

Mode Four-Points

Mode Three-Points

Plane XY

Plane YZ

Plane ZX

Record points

P1

P2

P3

P4

Page Up

Check points

Calculate

Save

Using the four-point method requires keeping a record of four location points

Step 2: Place the tip point TCP of the tool to be measured close to a fixed reference point from the first direction. Click the {Record P1} button with the servo power on to record the first position point. the background color of the {Record P1} button will change to green after the P1 point is recorded.

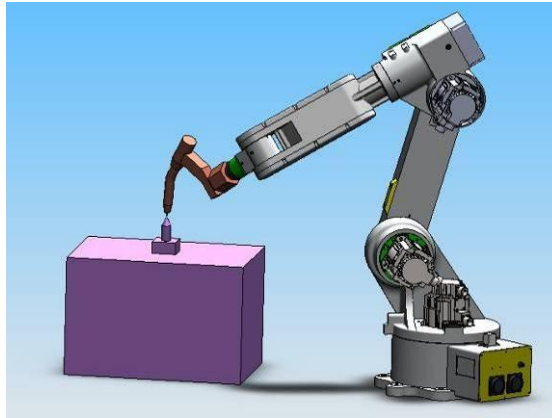

Step 3: Place the tip point TCP of the tool to be measured close to the same fixed reference point from the second direction. Click the {Record P2} button with the servo power on to record the second position point. the background color of the {Record P2} button will change to green after the P2 point is recorded.

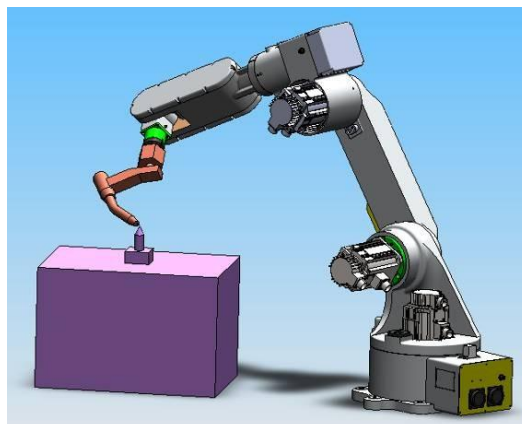

Step 4: Place the tip point TCP of the tool to be measured close to the same fixed reference point from the third direction. Click the {Record P3} button with the servo power on to record the third position point. the background color of the {Record P3} button will change to green after the P3 point is recorded.

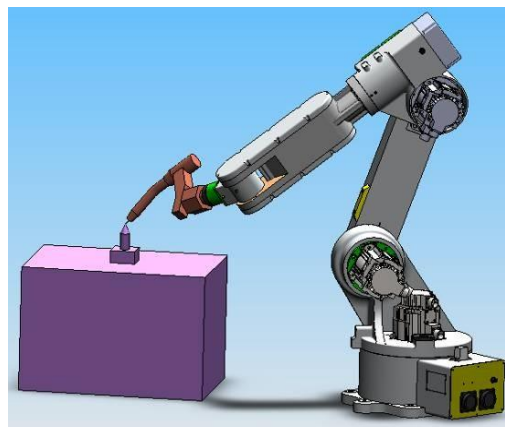

Step 5: Place the tip point TCP of the tool to be measured close to the same fixed reference point from the fourth direction. Click the {Record P4} button with the servo power on to record the fourth position point. the background color of the {Record P3} button will change to green after the P3 point is recorded.

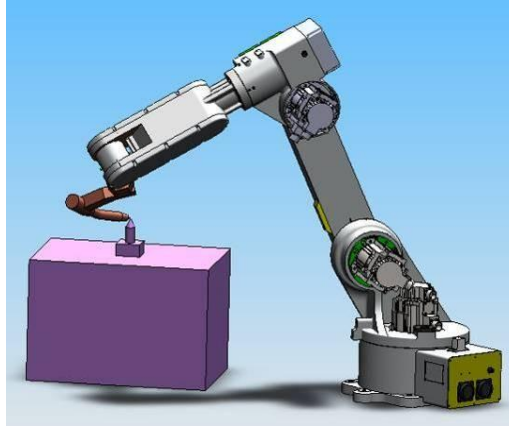

Step 6: {4-point method} After the required four position points are recorded click the {Calculate} button to automatically calculate the TCP position point data and display the calculation result.

Note that if two or more identical position points are recorded in the four-point method, the calculation will not succeed and the program will report an error.

Step 7: Click the {Save Results} button to save the recorded coordinates of the demonstrated position points and the calculated coordinate system data, and return to the main coordinate system management interface.

Step 8: Click on the {Set as current} button to make the calculated TCP tool the flange end tool. At this point, all steps from the tool coordinate system calculation to switching the newly calculated tool to the currently used tool have been completed. The tool coordinate system is calculated and switched successfully, and the robot can now perform various motions with the new tool.

Note that using the four-point method only determines the position offset value of the tool tip (center) point TCP relative to the end flange mounting surface of the robot; when the user needs to teach the determination of the tool attitude component, an additional three-point method is required, or the six-point method is used directly.

6.5.2.3 3-point method: calibrating attitude offsets

{3-point method} The steps to teach and calculate the attitude component of the instrumental coordinate system TCS are as follows.

Step 1: Select the serial number of the tool coordinate system to be modified or refreshed, and select the three-point method working mode.

In the three-point method working mode, three position points need to be recorded, i.e., point P1, point P2, and point P3. In addition, the user needs to select the plane in which the taught points are located, as shown below, and select the XY plane. That is, the schematic P1 and P2 points are used to determine the direction of the X-axis of the tool coordinate system, and the P3 point is on the positive side of the Y-axis of the XY plane of the tool coordinate system. Since the three-point method only determines the attitude component of the tool coordinate system TCP, the XY plane of the teach is only required to be parallel to the XY plane of the actual tool coordinate system TCS, and it is not required to be the XY plane of the TCS, and point P1 is a point on the X axis of the coordinate system of the selected XY teach plane, and it is not required to be the tool tip (center) point TCP (the origin of the tool coordinate system), and points P2 and P3 points are also so required.

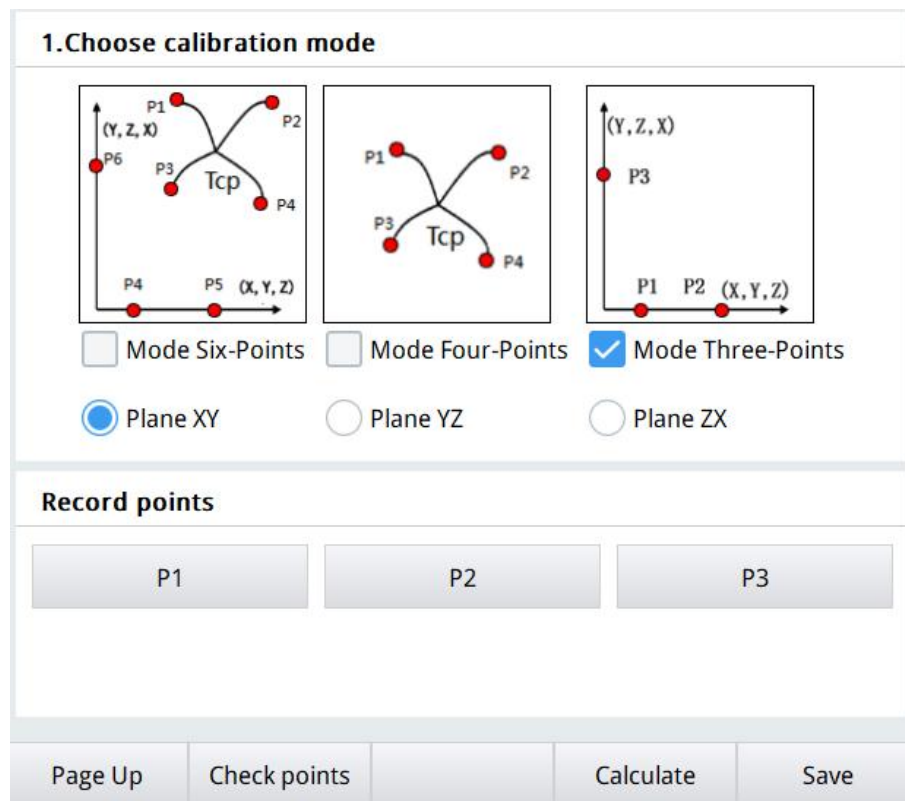

Figure 15 Selecting the three-point method working mode

Step 2: As shown below, first record the first point in the X-axis direction on the tool coordinate system, i.e., point P1.

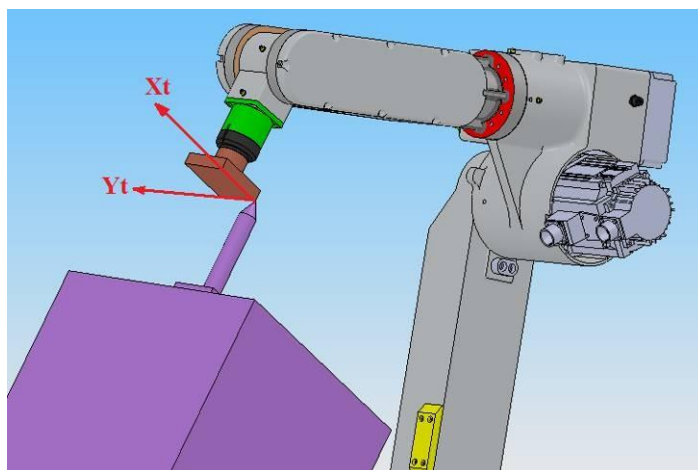

Figure 16 Recording point P1 (first point P1 in the positive direction of the X-axis)

Step 3: Record the second point in the direction of the X-axis on the tool coordinate system, i.e. point P2.

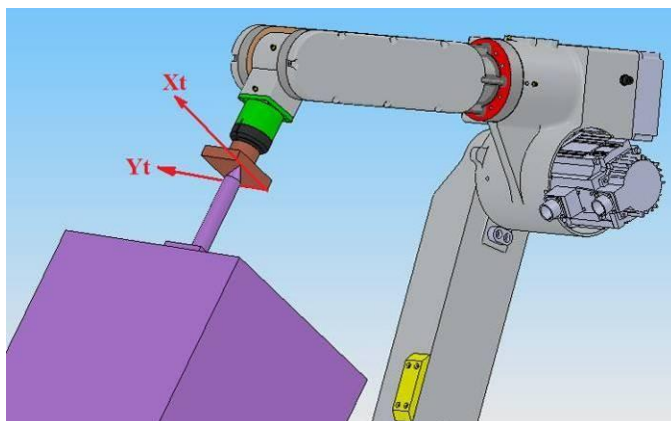

Figure 17 Recording point P2 (second point P2 in the positive direction of the X-axis)

Step 4: Record a point in the positive direction of the Y-axis in the XY plane on the tool coordinate system, i.e. point P3.

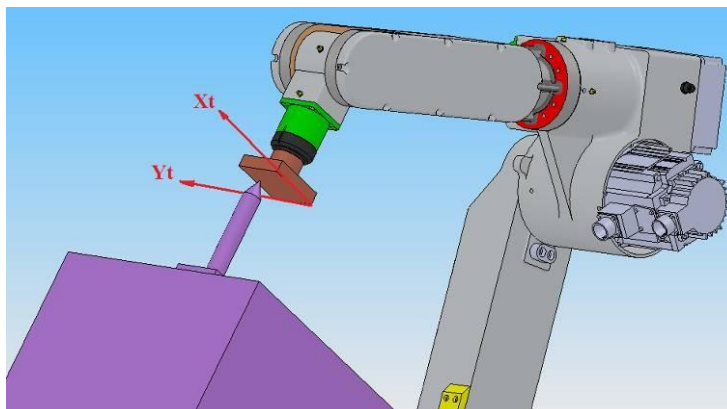

Figure 18 Recording P3 points (points in the positive direction of the Y-axis in the XY plane)

Step 5: Click on the {Calculate} button and the program generates the tool coordinate system attitude component data based on the recorded points P1, P2 and P3 and click on {Save Results} to update the attitude component of the tool coordinate system TCS for the selected coordinate system serial number.

It should be noted that when the three-point method (three position points to be recorded) is used to determine the tool attitude, these three position points can only be taught by moving motions in Cartesian space (i.e., only moving motions of XYZ under KCS, WCS, PCS, and TCS can go, but not rotational motions of XYZ or single joint rotation motions under ACS can be taught), and cannot be taught by rotational. Otherwise, the attitude component of the tool coordinate system cannot be calculated and an error warning will be given.

6.5.2.4 6-point method: offset of calibration position and attitude

The screenshot displays the BAYKAL control interface for coordinate system calibration. At the top, the status bar shows 'Fluzh01 : Move' and '*****Standby*****'. The main area is titled 'Coordinate Calibration Result' and displays the following data:

X:	124.5992	Roll:	2.8660
Y:	-2.0433	Pitch:	-33.5511
Z:	413.0664	Yaw:	171.8405

Below the results, the '1. Choose calibration mode' section offers three options: 'Mode Six-Points' (selected), 'Mode Four-Points', and 'Mode Three-Points'. Underneath, there are radio buttons for 'Plane XY' (selected), 'Plane YZ', and 'Plane ZX'. Each mode is accompanied by a 3D diagram showing the tool center point (Ttcp) and the selected calibration points (P1-P6) relative to the coordinate axes.

The 'Record points' section contains a grid of buttons for P1 through P6. At the bottom, there are buttons for 'Page Up', 'Check points', 'Calculate', and 'Save'.





Figure 19 Tool coordinate system calibration interface

The tool coordinate system calibration methods are {6-point method}, {4-point method} and {3-point method}, and three methods are available. The {6-point method} can synthesize the position offset and attitude vector of the tool TCP (TOOL CENTER POINT) at the end of the 6-axis articulated robot; the {4-point method} can only calculate the position offset value of the TCP at the end of the tool of the 6-axis robot, but not the attitude vector of the tool; the {3-point method} can only calculate the attitude vector of the TCP at the end of the tool of the 6-axis robot, but not the TCP position offset value of the tool end. The {6-point method} is actually a combination of the {4-point method} and the {3-point method}. The first four position points recorded in the {6-point method} use the {4-point method} to calculate the position offset of the TCP at the end of the tool, and the last three position points use the {3-point method} to calculate the TCP pose vector of the tool.

6.6 Workpiece Coordinate System(PCS)

6.6.1 Workpiece coordinate system axis movement

When the coordinate system is set to the workpiece coordinate system PCS in the teach mode, the robot tool end TCP moves in translation along the X, Y, and Z axes of the PCS coordinate system and in rotation around the X, Y, and Z axes of the PCS coordinate system, refer to the following table for the movements of each axis when the axis operation key is pressed and held.

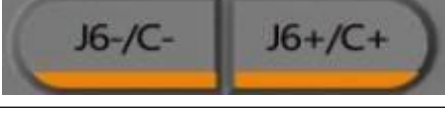
Shaft Name		Axis operating keys	movements
mobile shaft	X-axis		Translational motion along the X-axis of the PCS coordinate system
	Y-axis		Translational motion along the Y-axis of the PCS coordinate system
	Z-axis		Translational motion along the Z-axis of the PCS coordinate system
axis of rotation	around the X-axis		Rotational motion about the X-axis in PCS coordinates
	Around the Y-axis		Rotational motion around the Y-axis in PCS coordinates
	Around the Z-axis		Z-axis rotational motion around PCS coordinates

6.6.2 Calibration of the workpiece coordinate system

The user can access this calibration management interface through the submenu {Coordinate System Management} under the System Applications menu.

6.6.2.1 Explanation of calibration method parameters

Calibration plane.

XY: The calibration selects three points P1-P3 located in the XY plane, and the Z-axis direction is derived from the X-axis and Y-axis according to the right-hand rule of fork multiplication.

YZ: The calibration selects three points P1-P3 located in the YZ plane, and the X-axis direction is derived from the X-axis and Y-axis according to the right-hand rule of fork multiplication.

ZX: The calibration selects three points P1-P3 located in the ZX plane, and the Y-axis direction is derived from the Z-axis and X-axis by fork multiplication according to the right-hand rule.

Mode.

Three point method mode 1: Take the XY calibration plane as an example, P1 is the origin position, P2 is a point in the positive direction of the X-axis, and P3 is a point in the XY plane. The origin of the coordinate system taught by this method is located at the point P1, the positive direction of the X-axis points from the point P1 to the point P2, and the point P3 is located on the positive side of the Y-axis. the same applies to the YZ plane and the ZX plane

Three point method mode 2: Take XY calibration plane as an example, a point P1 and another point P2 on X-axis, teach a third point P3 on Y-axis. make a vertical line of P1-P2 line through the point P3, and the position of the foot is the origin of the coordinate system. The positive direction of the X-axis of the coordinate system taught in this way points from point P1 to point P2, and point P3 lies on the positive half of the Y-axis.

Origin offset: the user uses the coordinate system taught by the above two methods to offset to the O0 position point of the teach record.

Id: < 2/32 >

Type: PCS ▼ TCS:1 PCS:2 WCS:1

Coordinate Calibration Result

X:	771.5115	Roll:	179.9998
Y:	159.0738	Pitch:	-0.0003
Z:	848.5609	Yaw:	97.5669

1. Choose calibration mode

HomePosition Offse

Plane XY

Mode Three-Points

Plane YZ

Mode Three-Points

Plane ZX

Record points

P1	P2	P3
O		

Page Up Check points Calculate Save

Figure 20Workpiece coordinate system calibration interface

6.6.2.2 How to calibrate a coordinate system for a workpiece

Step 1: Select the coordinate system serial number and type

The default (1) coordinate system cannot be modified, so please select the calibration from #2.

Step 2: Select the calibration method

Select the calibration method {Triple point method mode 1}, {Triple point method mode 2}, see "Explanation of calibration method parameters" above for details.

In addition the user can add an additional recorded coordinate home offset position point O0 point. This position point is optional and when the user uses this function, the coordinate system taught by the user using the two methods described above can be offset to the O0 position point recorded by the teach, while the attitude of the coordinate system remains unchanged.

The user can select the coordinate system plane for the demonstration by pressing the {XY}, {YZ}, and {ZX} buttons on the interface.

Step 3: Location point recording

Movement to the position point, click the corresponding button, the background color of the button turns green (as shown in the figure below) indicates successful recording. Note that the position points calibrated should not be too close to each other.

Id: 2/32

Type: WCS TCS:1 PCS:2 WCS:1

Coordinate Calibration Result

X:	841.7936	Roll:	0.0000
Y:	207.0280	Pitch:	-0.0003
Z:	848.5644	Yaw:	-180.0000

1. Choose calibration mode

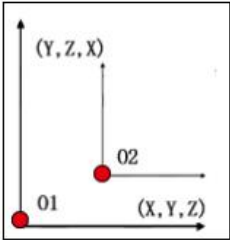

HomePosition Offse

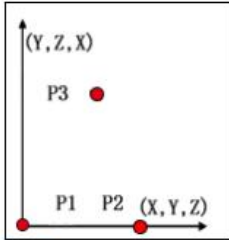

Mode Three-Points

Plane XY

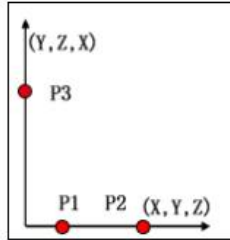

Mode Three-Points

Plane YZ

Record points

P1

P2

P3

Page Up
Check points
Calculate
Save

Figure 21 Workpiece coordinate system calibration interface2

Step 4: Calculate and save the results

Click {Calculate} and if it shows success click {Save Results}; if it fails an alarm will be displayed in the status bar, modify or recalibrate according to the alarm prompt.

In addition, on the position point recording screen, the user clicks the {show point} button to enter the show point management screen. In this interface, the user can view the recorded position point data and can make the robot move to the specified recorded point. First select the recorded position point, then put the robot in servo enable state, select the point P1, P2, P3 and {Move to Point}, press and hold [Forward], the robot moves towards the specified position point in linear motion mode. Click {Previous} to return to the calibration screen.

Id:

←
2/32
→

Type:

WCS

▼

TCS:1

PCS:2

WCS:1

Choose point

P1

P2

P3

Joints position

J1:	-0.6579	J5:	89.3373
J2:	-29.0242	J6:	-0.6571
J3:	29.6012	J7:	0.0000
J4:	0.0018	J8:	0.0000

Page up

MoveToPoint

Figure 22 Demonstration Point View Screen

Step 5: Set to current

After calibrating a workpiece coordinate system, return to the coordinate system management interface and set the calibrated coordinate system to the currently used coordinate system. Check that the " T3P5 " on the status bar shows the set coordinate system number, T is the tool coordinate system, and P is the workpiece coordinate system.





Step 6: Validate the coordinate system

The directional accuracy of the calibrated coordinate system is verified by the translational motion of the TCP at the end of the robot tool along the X, Y, and Z axes of the PCS coordinate system and the rotational motion around the X, Y, and Z axes of the PCS coordinate system at the point (tip).

6.7 World Coordinate System

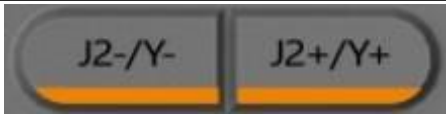
6.7.1 axis action

When the coordinate system is set to the world coordinate system WCS in the teach mode, the robot tool end TCP moves parallel along the X, Y and Z axes of the WCS coordinate system and rotates around the X, Y and Z axes of the WCS coordinate system, refer to the following table for the movements of each axis when the axis operation key is pressed and held.

Shaft Name		Axis operating keys	movements
mobile shaft	X-axis		Translational motion along the X-axis of the WCS coordinate system
	Y-axis		Translational movement along the Y-axis of the WCS coordinate system
	Z-axis		Translational motion along the Z-axis of the WCS coordinate system
axis of rotation	around the X-axis		X-axis rotational motion around WCS coordinates
	Around the Y-axis		Rotational motion around the Y axis in WCS coordinates
	Around the Z-axis		Z-axis rotational motion around WCS coordinates

6.7.2 World coordinate system calibration

The main interface of WCS calibration management is shown below, and the user can access this calibration interface through the submenu {Coordinate System Management} under the menu {System Application}, and select the WCS serial number. The calibration process of WCS is the same as the calibration process of workpiece coordinate system PCS, and the specific calibration operation is the same as the workpiece coordinate system calibration.

7 System Parameter

Click Logo in the upper left corner to open {System Applications} and select {System Parameters} to set the parameters.

Click {Save} below to save the parameters when you are done setting them.

Selecting the setting parameters can be done quickly by using the {Copy} {Paste} buttons.

7.1 System Parameters

The screenshot shows the 'System Par' interface. On the left is a sidebar with icons and labels for 'System Par', 'Device Par', 'Joint Par', 'Aux axis', 'Decare Par', 'Profile Par', 'DH', and 'Coupling'. The 'System Par' option is selected. The main panel, titled 'System Par', contains five settings, each with a dropdown menu:









Parameter	Value
1.Remote controler mode	IO
2.Boot coordinate type	ACS
3.Start line	Current line
4.Check ControlBox connection state	uncheck
5.Auto note for cmd	open

At the bottom right of the main panel are two buttons: 'Save' and 'Reset'.

Figure 23 System Parameters Interface

Serial number	1	2	3	4	5
Parameter Name	Remote controller mode	Boot coordinate type	Start line	Check control box connection state	Auto note for cmd
Parameter Options	Tcp/Ip IO	ACS KCS PCS PCS2 WCS TCS	Current line Last stop line Top line	uncheck check	Close open

7.2 Hardware Parameters

- 
System Par
- 
Device Par
- 
Joint Par
- 
Aux axis
- 
Decare Par
- 
Profile Par
- 
DH
- 
Coupling

Device Par

Axis id: Copy Paste

1. Encoder plan resolution	<input type="text" value="131072"/>
2. Encoder feedback resolution	<input type="text" value="131072"/>
3. Encoder port	<input type="text" value="COM2"/> ▼
4. Encoder type	<input type="text" value="GthdEcat"/> ▼
5. Encoder reading cycle	<input type="text" value="98"/>
6. Motor maximum speed(rpm)	<input type="text" value="3500"/>
7. Motor maximum current(A)	<input type="text" value="39.0000"/>
8. Motor torque constant(Nm/A)	<input type="text" value="0.7300"/>
9. Motor ratio at joint side	<input type="text" value="1.0000"/>
10. Ratio at motor side	<input type="text" value="81.0000"/>

Figure 24 Hardware Parameters Interface

List of parameters.

Serial number	Parameter Name	Parameter Description
1	Encoder planning resolution	Example of number of encoder lines: 17-bit encoder with a resolution of 131072
2	Encoder feedback resolution	
3	Read absolute encoder port	Bus-based control value This parameter is invalid
4	Encoder type	Default GthdEcat
5	Cyclic reading absolute encoder	Timed reading of absolute encoder data to refresh the current absolute position of the robot

6	Maximum motor speed (rpm)	The maximum speed of the motor, which is not allowed to be exceeded during actual operation
7	Maximum motor current (A)	The maximum motor current, which is not allowed to be exceeded during actual operation
8	Motor torque constant (Nm/A)	Torque generated per unit of current
9	Reduction ratio joint end	Ratio of rotation angle at the motor end to rotation angle at the actuator end (positive or negative values are allowed to change the direction of joint movement)
10	Reduction ratio motor end	

7.3 Joint (Physiology)



System Par



Device Par



Joint Par

Aux axis

Decare Par

Profile Par

DH

Coupling

Joint Par

Axis id: Copy Paste

1. Joint Type	<input style="width: 80%;" type="text" value="RotationJoint(deg)"/>
2. Positive Limit(deg)	<input style="width: 80%;" type="text" value="165"/>
3. Negative Limit(deg)	<input style="width: 80%;" type="text" value="-165"/>
4. JointHomeOffset	<input style="width: 80%;" type="text" value="0.0000"/>
5. Axis sign	<input style="width: 80%;" type="text" value="None"/>
6. Joint "JOG" max speed(deg/s)	<input style="width: 80%;" type="text" value="40"/>
7. MOVJ max jog acc(deg/s^2)	<input style="width: 80%;" type="text" value="200"/>
8. Joint "JOG" Max Dec(deg/s^2)	<input style="width: 80%;" type="text" value="200"/>
9. MovJ Max speed (deg/s)	<input style="width: 80%;" type="text" value="259"/>
10. MOVJ max acc(deg/s^2)	<input style="width: 80%;" type="text" value="1200"/>
11. MOVJ max dec(deg/s^2)	<input style="width: 80%;" type="text" value="800"/>
12. Axis addr	<input style="width: 80%;" type="text" value="1"/>

Figure 25 Joint Parameters Interface

List of parameters.

Serial number	Parameter Name	Parameter Description
1	Type of joint	Non-use. Swivel joints (deg). Translating joints (mm).
2	Positive joint limitation	Maximum joint range of motion
3	negative joint limit	Minimum joint range of motion
4	Joint Zero Offset	Deviation values of the user-defined joint zero point from the zero point of the internal robot model of the system
5	joint reversal	User defines whether the direction of joint rotation is opposite to the direction of the robot model inside the system
6	Joint JOG maximum speed	Maximum velocity of point-axis operation key motion in the joint coordinate system
7	Joint JOG maximum acceleration	Maximum value of acceleration of point-action axis operation key motion in the joint coordinate system
8	Joint JOG maximum deceleration	Maximum value of deceleration of point-action axis operation key motion in the joint coordinate system
9	Maximum speed of joint movement	MOVJ command joint motion speed maximum
10	Maximum acceleration of joint motion	MOVJ command joint motion acceleration maximum
11	Maximum deceleration of joint motion	MOVJ command joint motion deceleration maximum
12	Axis hardware address	The station number used for bus communication should match the host computer settings

7.4 Auxiliary Shaft

The auxiliary axis parameter is set with reference to the {Joint} parameter, and the parameter 1 {Joint Type} is selected as "Unused" for the auxiliary axis that is not used.

Aux Axis Par	
Axis id:	Ex1
1. Joint Type	reserve
2. Positive Limit(X)	60
3. Negative Limit(X)	-60
4. JointHomeOffset(X)	0.0000
5. Axis sign	None
6. Joint "JOG" max speed(X/s)	10
7. max jog acc(X/s ²)	90
8. Joint "JOG" max Dec(X/s ²)	90
9. MovJ Max speed (X/s)	30
10. MOVJ max acc(X/s ²)	100
11. MOVJ max Dec(X/s ²)	100
12. Axis addr	7

Figure 26 Auxiliary axis parameter interface

7.5 Descartes

Decare Par		
System Par	1. Axis X:	
	Positive limit(mm)	9999
	Negative limit(mm)	-9999
Device Par	"JOG" mode max Vel(mm/s)	150
	"JOG" mode max Acc(mm/s ²)	1000
Joint Par	"JOG" mode max Dec(mm/s ²)	1000
	2. Axis Y:	
	Positive limit(mm)	9999
	Negative limit(mm)	-9999
Aux axis	"JOG" mode max Vel(mm/s)	150
Decare Par	"JOG" mode max Acc(mm/s ²)	1000
	"JOG" mode max Dec(mm/s ²)	1000
	3. Axis Z:	
	Positive limit(mm)	9999
	Negative limit(mm)	-9999
Profile Par	"JOG" mode max Vel(mm/s)	150
	"JOG" mode max Acc(mm/s ²)	1000
	"JOG" mode max Dec(mm/s ²)	1000
DH		
Coupling		
		Save
		Reset

Decare Par		
System Par	4. Axis RX:	
	Positive limit(deg)	9999
	Negative limit(deg)	-9999
Device Par	JOG(deg/s)	20
	"JOG" mode max Acc(deg/s ²)	120
Joint Par	"JOG" mode max Dec(deg/s ²)	120
	5. Axis RY:	
	Positive limit(deg)	9999
	Negative limit(deg)	-9999
Aux axis	JOG(deg/s)	20
Decare Par	"JOG" mode max Acc(deg/s ²)	120
	"JOG" mode max Dec(deg/s ²)	120
	5. Axis RZ:	
	Positive limit(deg)	9999
	Negative limit(deg)	-9999
Profile Par	JOG(deg/s)	20
	"JOG" mode max Acc(deg/s ²)	120
	"JOG" mode max Dec(deg/s ²)	120
DH		
Coupling		
		Save
		Reset

Decare Par		
System Par	Positive limit(deg)	9999
	Negative limit(deg)	-9999
Device Par	JOG(deg/s)	20
	"JOG" mode max Acc(deg/s ²)	120
	"JOG" mode max Dec(deg/s ²)	120
	5. Axis RZ:	
	Positive limit(deg)	9999
	Negative limit(deg)	-9999
Aux axis	JOG(deg/s)	20
Decare Par	"JOG" mode max Acc(deg/s ²)	120
	"JOG" mode max Dec(deg/s ²)	120
	7. Maximum speed:	
	speed(mm/s)	1998
Profile Par	Position Acc(mm/s ²)	9000
	Position Dec(mm/s ²)	9000
	speed(deg/s)	100
DH	Orientation Acc(deg/s ²)	300
	Orientation Dec(deg/s ²)	300
Coupling		
		Save
		Reset

Figure 27 Cartesian Parameters Interface

List of parameters.

Serial number	Parameter Name	Parameter Description
1	positive limit	Maximum value of range of motion in Cartesian coordinate system
2	negative limit	Minimum value of range of motion in Cartesian coordinate system
3	JOG maximum speed	Maximum speed of motion of a point axis operating key in Cartesian coordinate system
4	JOG maximum acceleration	Maximum value of acceleration of point-action axis operation key motion in Cartesian coordinate system
5	JOG maximum deceleration	Maximum value of the deceleration of the motion of the operating key of the point axis in the Cartesian coordinate system
6	linear velocity	Maximum value of synthetic linear velocity at the end of a point in a Cartesian coordinate system
7	linear acceleration	Maximum value of synthetic linear acceleration at the end of a point in a Cartesian coordinate system
8	linear deceleration	The maximum value of the synthetic linear deceleration at the end of the point in the Cartesian coordinate system
9	angular velocity	The maximum value of the synthetic angular velocity at the end of a point in the Cartesian coordinate system
10	angular acceleration	Maximum value of the synthetic angular acceleration at the end of a point in the Cartesian coordinate system
11	angular deceleration	The maximum value of the synthetic angular deceleration at the end of a point in the Cartesian coordinate system

7.6 Planning Parameters

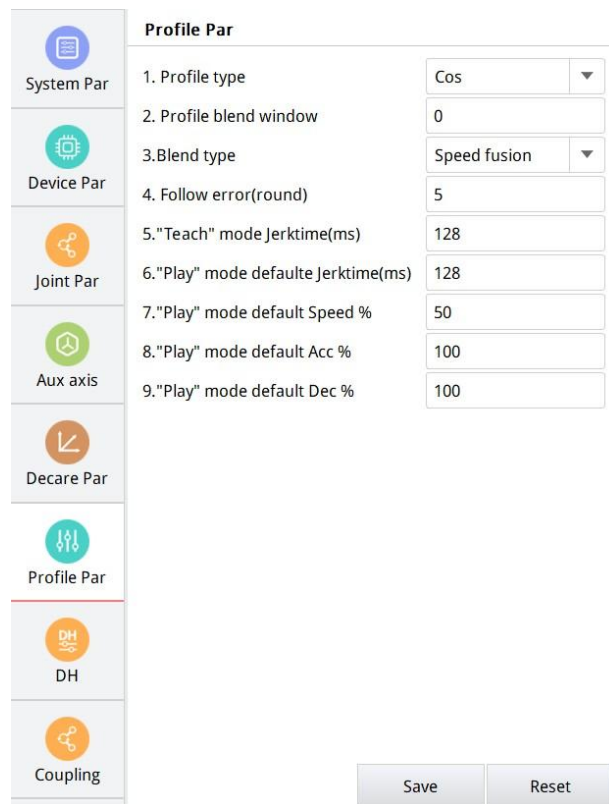
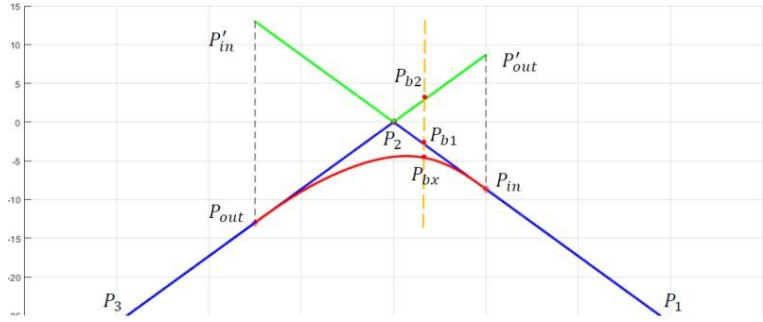

Figure 28 Planning parameters interface

List of parameters.

Serial number	Parameter Name	Parameter Description
1	Planner type	<p>Cos: Jerk is the trajectory planning of the Cos function</p> <p>Quintic: Jerk is 5 times the trajectory planning of the curve</p> <p>Door: Jerk is the trajectory planning for square waves</p> <p>SawTooth: Jerk is a sawtooth trajectory plan</p> <p>Exp: Jerk is an exponential curve for trajectory planning</p> <p>Bell: Jerk is a trajectory plan for quadratic curves</p> <p>Refer to the chart below for planning curves</p>
2	Planner Smoothing Window	Output Mean Filter Length

3	Type of track transition segment	<p>Fusion: path mixing transition, no abrupt changes in velocity and acceleration, controllable trajectory, but not constant velocity, default option</p> <p>Arc: Circular transition, ensures constant velocity and controllable trajectory in the transition section, but causes abrupt acceleration changes. Not suitable for joint trajectory and attitude planning.</p> <p>Spline: spline transition, guarantees constant velocity and controllable trajectory in the transition section, but causes abrupt acceleration change, which is smaller than Arc transition. Not suitable for joint trajectory and attitude planning</p> <p>VelBlend: Velocity transition, i.e. two motion commands are planned simultaneously to perform velocity superposition and get a new position. The trajectory shape is related to the velocity when entering the Blend segment</p>  <p>Fig: 末端位置路径混合</p>
4	Following error (round)	The difference between the position command and the actual position in the time period from the start of the movement to the actual position
5	Acceleration time of the planner in demonstration mode	The acceleration time used when jogging manually, turn up the jog will be more violent, easy to shake
6	Auto-run default plus acceleration time	When playing back, if the program does not call SetDyn, then the default acceleration time is to use this value, which is the jerktime in SetDyn
7	Auto-run default speed percentage	Boot default playback mode running speed
8	Auto-run default acceleration percentage	Boot default playback mode running acceleration
9	Auto-run default deceleration percentage	Boot default playback mode runs at reduced speed

Planner type illustration.

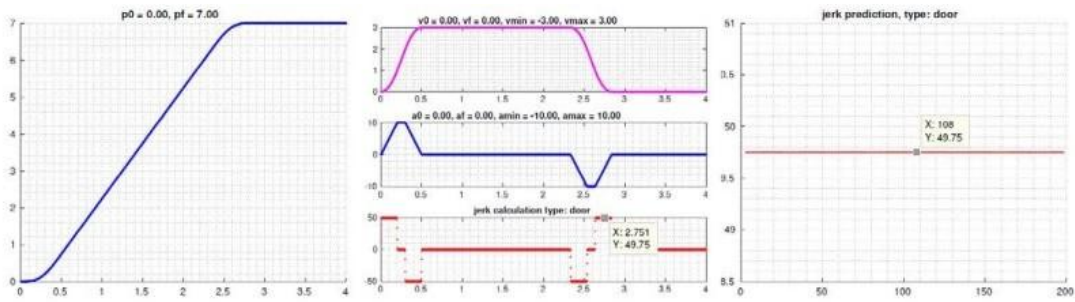

Figure 1: door-shaped jerk

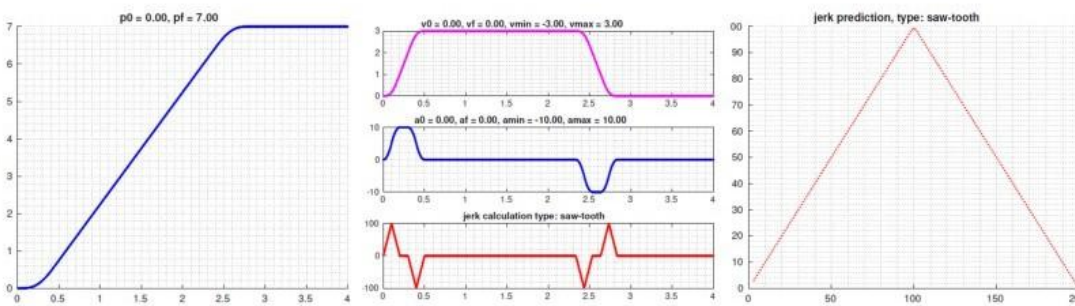

Figure 2: saw-tooth-shaped jerk

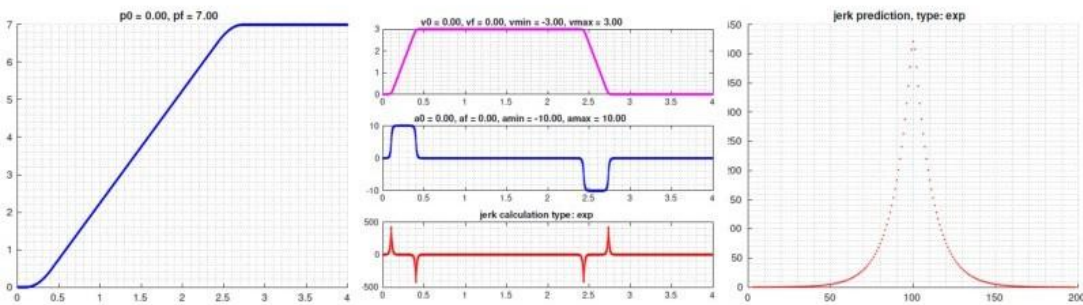

Figure 3: exp-shaped jerk

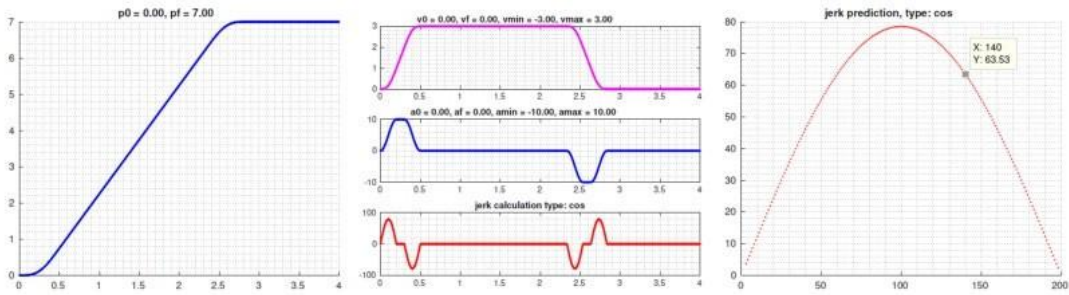

Figure 4: cos-shaped jerk

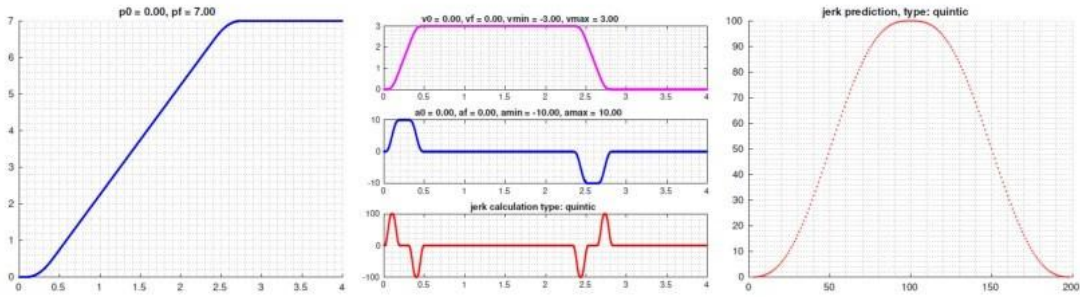

Figure 5: quintic-shaped jerk

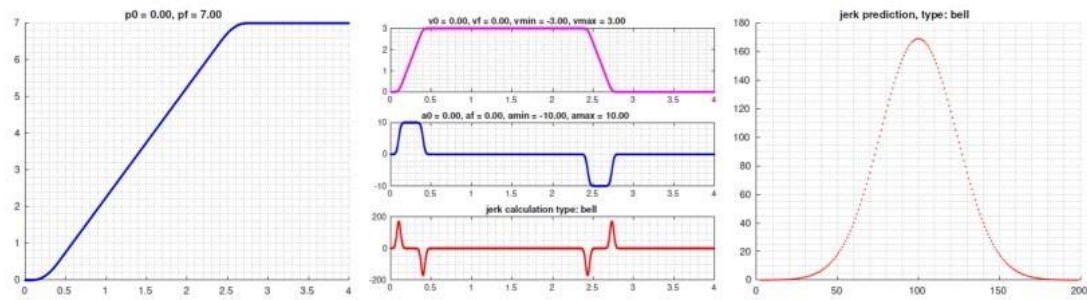
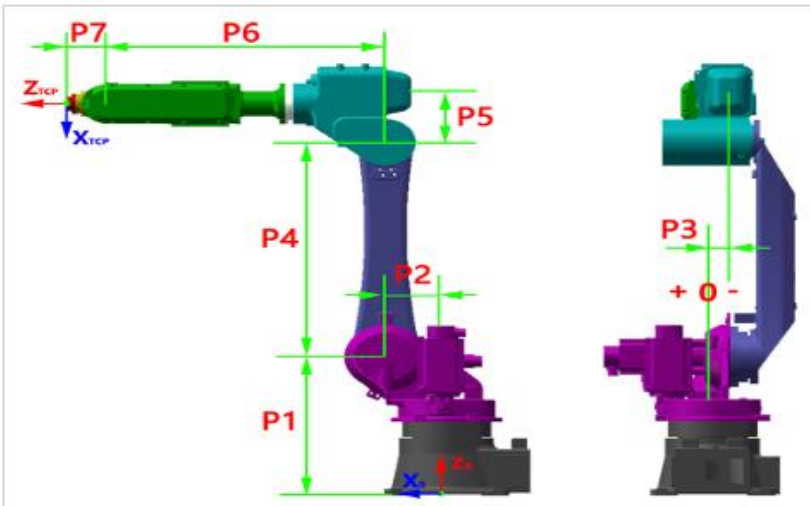

Figure 6: bell-shaped jerk

7.7 DH Parameters

DH参数



P1	<input type="text" value="430.000"/>	P2	<input type="text" value="164.680"/>
P3	<input type="text" value="0.000"/>	P4	<input type="text" value="550.320"/>
P5	<input type="text" value="210.060"/>	P6	<input type="text" value="700.200"/>
P7	<input type="text" value="115.000"/>	P8	<input type="text" value="0.000"/>
P9	<input type="text" value="0.000"/>	P10	<input type="text" value="0.000"/>
P11	<input type="text" value="0.000"/>	P12	<input type="text" value="0.000"/>
P13	<input type="text" value="0.000"/>	P14	<input type="text" value="0.000"/>
P15	<input type="text" value="0.000"/>	P16	<input type="text" value="0.000"/>
P17	<input type="text" value="0.000"/>	P18	<input type="text" value="0.000"/>

Figure 29DH Parameters Interface

List of parameters:

Serial number	Parameter Name	Parameter Description
1	P1~P7	Please fill in the information of each parameter according to the diagram
2	P8/P9	Coupling ratio between shaft 4 and shaft 5
3	P10/P11	denotes the coupling ratio between axis 6 and axis 4
4	P12/P13	denotes the coupling ratio between axis 6 and axis 5
5	P14~P18	reserve

7.8 Coupling

Coupling

Id	Driving	Driven	Value
1	5	6	-0.13330
2	0	0	0.00000
3	0	0	0.00000
4	0	0	0.00000
5	0	0	0.00000
6	0	0	0.00000
7	0	0	0.00000
8	0	0	0.00000
9	0	0	0.00000
10	0	0	0.00000

Save Reset

Figure 30 Coupling ratio setting interface

8 General IO

The generic IO is mainly configured for generic signals such as anti-collision, pause, restart, alarm reset and safety gate.

8.1 Input Signal

8.1.1 interface







DIN DOUT					
ID	Function	Group	Index	Level	Status
1	Anti collision	1	0	1	
2	ForbitMove	1	0	1	
3	Pause	1	0	1	
4	Safegate	1	0	1	
5	Emergency stop	1	0	1	
6	highTemperater	1	0	1	
7	batteryError	1	0	1	

Figure 31IO Input Interface

Module: indicates the IO module address ID, the extended IO slave address ID takes the value starting from 1.

Point: indicates the first bit of the module to be used, 0 means not used, and the point takes the value from 1.

Valid values: normal 1 is valid and can be taken in reverse.

Status: Point input status indicator, shown as green when signal is triggered, gray when no signal is present.

8.1.2 Function description















Serial number	Input and Output Type	Parameter Name	instructions
1	Digital input	Anti-collision signal	After the system detects the anti-collision signal trigger, it stops the movement urgently and prompts the anti-collision signal trigger alarm.
2	Digital input	External ban on robots	The system detects an external ban robot signal trigger with a yellow warning indication that the robot is prohibited from moving.

3	Digital input	pause (media player)	When the system detects a pause signal trigger, the system suspends execution of the schematic file.
4	Digital input	security door	The system detects that the safety door signal is triggered and stops the movement in an emergency, prompting the safety door alarm.
5	Digital input	emergency stop	When the system detects the emergency stop signal trigger, it stops the movement in an emergency, prompting an emergency stop alarm.
6	Digital input	High Temperature Alarm	When the system detects a high temperature alarm signal trigger, it stops the movement and indicates a high temperature alarm.
7	Digital input	Battery Alarm	When the system detects a battery alarm signal trigger, it stops the movement and indicates a battery alarm.

8.2 Output Signal

8.2.1 Interfac e

Figure 32IO Output Interface

DIN		DOUT				
ID	Function	Group	Index	Level	Status	
1	Servo	1	0	1		
2	Idle	1	0	1		
3	Error	1	0	1		
4	Pause	1	0	1		
5	Work	1	0	1		
6	Warn	1	0	1		
7	Moving	1	0	1		
8	TeachMode	1	0	1		
9	PlayMode	1	0	1		
10	RemoteMode	1	0	1		
11	TpPause	1	0	1		
12	TpEstop	1	0	1		
13	TpStart	1	0	1		
14	TpThreeSwitch	1	0	1		
15	StationEstop	1	0	1		

<
1 / 1
>

Module: indicates the IO module address ID, the extended IO slave address ID takes the value starting from 1.

Point: indicates the first bit of the module to be used, 0 means not used, and the point takes the value from 1.

Valid values: normal 1 is valid and can be taken in reverse.

Status: Point input status indicator, shown as green when signal is triggered, gray when no signal is present.

8.2.2 Function description

Serial number	Input and Output Type	Parameter Name	instructions
1	Digital output	Servo Enable	Output signal after robot enable
2	Digital output	leisure time	Enable in standby mode
3	Digital output	Alarm (red alarm)	The robot is in a red alarm abnormal state
4	Digital output	pause (media player)	The robot is on hold.
5	Digital output	at work	The robot is in the state of executing a show-and-tell file.
6	Digital output	Warning (yellow alert)	Robot is in warning alert status
7	Digital output	in motion	Robot in motion
8	Digital output	Demonstration mode status	Output signal when the handheld teach pendant is in the teach pendant mode
9	Digital output	Playback Mode Status	Output signal when the handheld teach pendant is in playback mode
10	Digital output	Remote Mode Status	Output signal when the handheld teach pendant is in remote mode
11	Digital output	Handheld box emergency stop output	Output signal when the emergency stop signal is triggered by the handheld box.
12	Digital output	Handheld box pause output	Output signal when the handheld box pause signal is triggered.
13	Digital output	Handheld box start output	Output signal when the handheld box start signal is triggered.
14	Digital output	Handheld box with three switch outputs	Outputs a signal when the handy box three-section switch enable button signal is triggered.
15	Digital output	Workstation emergency stop	A workstation emergency stop input signal is received and the system is in a workstation emergency stop.

8.3 IO Wiring

Take R51C1-EA/pro as an example, please refer to the instruction manual for specific IO wiring.

R51C1-EA/pro Wiring Diagram

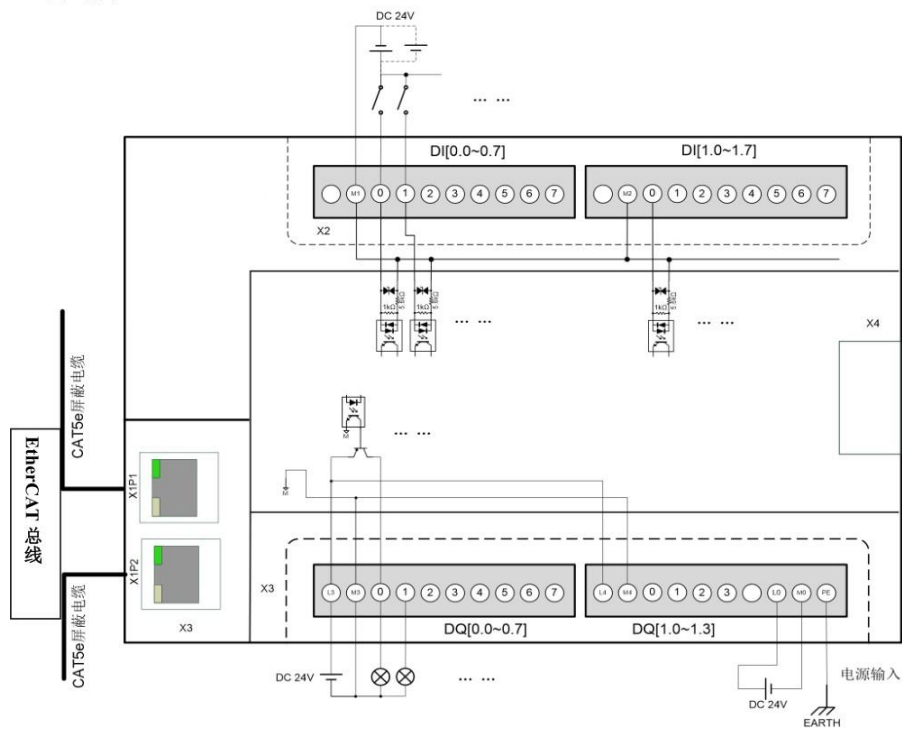

Ecat: Network cable connection

Power supply: 24V power supply, as shown in the lower right corner of the picture

Output: L3/L4 (QL0/QL1) is connected to 24V, M3/M4 (QM0/QM1) is connected to 0V, the output is 24V

Input: 24V if M1/M2 (IM0/IM1) is connected to 0V.

(a) If M1/M2 (IM0/IM1) is connected to 24V, then 0V is required.

9 Other Functions

9.1 Home Point Calibration



1. Teach-in and playback operations cannot be performed without home position calibration. For systems using multiple robots, home position calibration must be performed for each robot.
2. When there is a coupling relationship between the joint axes, for example, a common robot has a coupling relationship between the fifth axis and the sixth axis, the fifth axis must be in the zero position for the zero data recorded in the sixth axis to be valid, otherwise, the zero data recorded in the sixth axis is invalid. So the zero data of the sixth axis must be recorded while the fifth axis is in the zero position. If there is no coupling relationship, each axis can be calibrated separately for zero position and the respective zero position will not affect the zero position of other joints.
3. When all the used axes (body axes and auxiliary extension axes) have been zero-calibrated, the "All" indicator on the zero-calibration screen turns green, indicating that the robot has completed zero-calibration, and the robot is ready for movement in Cartesian space.

Immediately after clearing the encoder zero drift alarm, a mechanical zero position calibration and a software record calibration need to be performed for each axis of the robot.

Mechanical zero calibration: Performed as described below, i.e., by single-axis motion, so that each axis runs to the mechanical reference zero point.

Software Recorded Calibration: After all 6 axes have returned to the mechanical reference zero point through single axis motion, you need to go into the factory settings of the software and re-record the zero position. Make sure that the software hardware zero positions correspond. After that, each time the robot returns to zero it will return to that position.

Off
Teach
ACS
T1P2
5
50

Fluzh01 : Move

*****Standby***** Clear

1.Real-time absolute encoder data

1:	0	2:	0	3:	0	4:	0
5:	0	6:	0	7:	0	8:	0
Ex1:	0	Ex2:	0	Ex3:	0	Ex4:	0
Ex5:	0	Ex6:	0	Ex7:	0	Ex8:	0

Green indicates that the axis zero point is valid.

2.Current zero status and reference positon

<input checked="" type="radio"/> 1	0	Ex1	0
<input checked="" type="radio"/> 2	0	Ex2	0
<input checked="" type="radio"/> 3	0	Ex3	11
<input checked="" type="radio"/> 4	0	Ex4	12
<input checked="" type="radio"/> 5	0	Ex5	13
<input checked="" type="radio"/> 6	0	Ex6	14
<input type="radio"/> 7	0	Ex7	15
<input type="radio"/> 8	0	Ex8	16

Gray indicates that the axis zero point is invalid and needs to be recalibrated

Modify Refresh

3.Axis selection

<input type="checkbox"/> 1	<input type="checkbox"/> 2	<input type="checkbox"/> 3	<input type="checkbox"/> 4	<input type="checkbox"/> 5	<input type="checkbox"/> 6
<input type="checkbox"/> 7	<input type="checkbox"/> 8	<input type="checkbox"/> E1	<input type="checkbox"/> E2	<input type="checkbox"/> E3	<input type="checkbox"/> E4
<input type="checkbox"/> E5	<input type="checkbox"/> E6	<input type="checkbox"/> E7	<input type="checkbox"/> E8		

Clear robot default value of encoder Record Clear

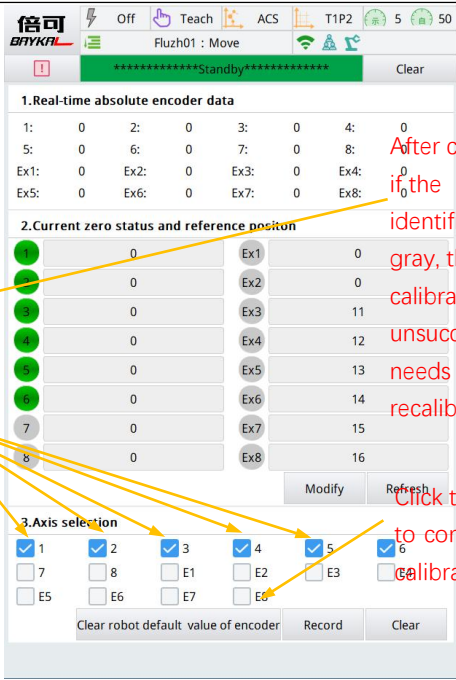
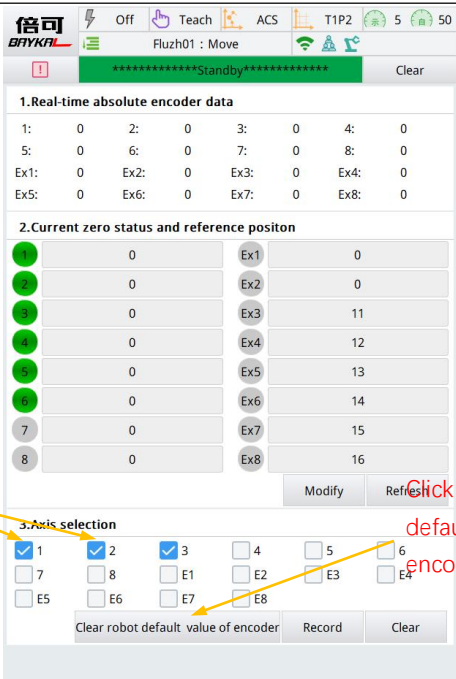
sports event	Operation steps
<p>Record zero.</p>	 <p>After the corresponding axis of the robot is moved to the zero position, select the axis to be calibrated</p> <p>After calibration, if the identification is gray, the calibration is unsuccessful and needs to be recalibrated</p> <p>Click the Record to complete the calibration</p>
<p>Absolute encoder zeroing (Change the zero data of the selected axis to 0)</p>	 <p>Select the axis to clear the zero position</p> <p>Click Clear robot default value of encoder</p>

Manually modify the zero point
(not recommended)

1. Click Modify

2. Modify the zero position data of the corresponding axis

3. Click Save to complete the modify

9.2 The 20-Point Method

The 20-point method is used to compensate for the zero point and the tool coordinate system.

Step 1: Use the end of the robot tool to go to the tip of the robot in different poses and record the position points, with as much variation as possible in the joint angle at each position.

1
 Record

Step 1: record point(V3.0)

points state: green-recorded gray-unrecord

The angle change of joints at adjacent points shall be as large as possible

1

2

3

4

5

6

7

8

9

10

11

12

13

14

15

16

17

18

19

20

Points: < 1 >

J1: -1.8313 J2: 9.5914

J3: 18.4394 J4: -0.0036

J5: 61.9883 J6: -1.8356

Clear Current

Clear All

Move to

Record

Step 2: Click to calculate

1
Record

Step 2: calculation

Input the coupling ratio and click [calculate] to obtain the res

Axis5,6	<input type="text" value="0.00000"/>	Axis4,5	<input type="text" value="0.00000"/>
Axis4,6	<input type="text" value="0.00000"/>	Axis2,3	<input type="text" value="0.00000"/>

1.Joint offset of default position

J1:	0.0000	J2:	0.7826
J3:	-0.2272	J4:	-0.2984
J5:	-1.2555	J6:	0.0000

2.TCP(mm)

X:	-0.3688	Y:	0.0912
Z:	149.7936		

3.Calibration error

平均误差(mm): 0.2816 最大误差(mm): 0.5243

Step 3: Click on {Manual Compensation}

1
Record

Step 3:compensate

Attention:

- 1.The compensation will modify the default position. After compensation, the previously recorded points will be invalid;
- 2.To reuse the previous points , manually restore the default position to the original value before compensation;
- 3.To calculate using the points recorded before compensation, manually restore the default position to the original value before compensation.

Select the compensation tool coordinate

9.3 Exception Handling

1.Current axis simulation Status

1	2	3	4	5	6	7	8
Ex1	Ex2	Ex3	Ex4	Ex5	Ex6	Ex7	Ex8

2.Alarm and limit

Limitation of the joint movement ● Cancel collision alarm ●

Green light means in effect, grey means normal.

9.4 Permissions Management

9.4.1 User switching

Login



Factory



Management



Operation

Password:

Change Password

New password : Factory

New password : Management

Boot Options

Boot factory Boot management Boot operation

Figure 33 User Switching Interface

9.4.2 Hardware Testing

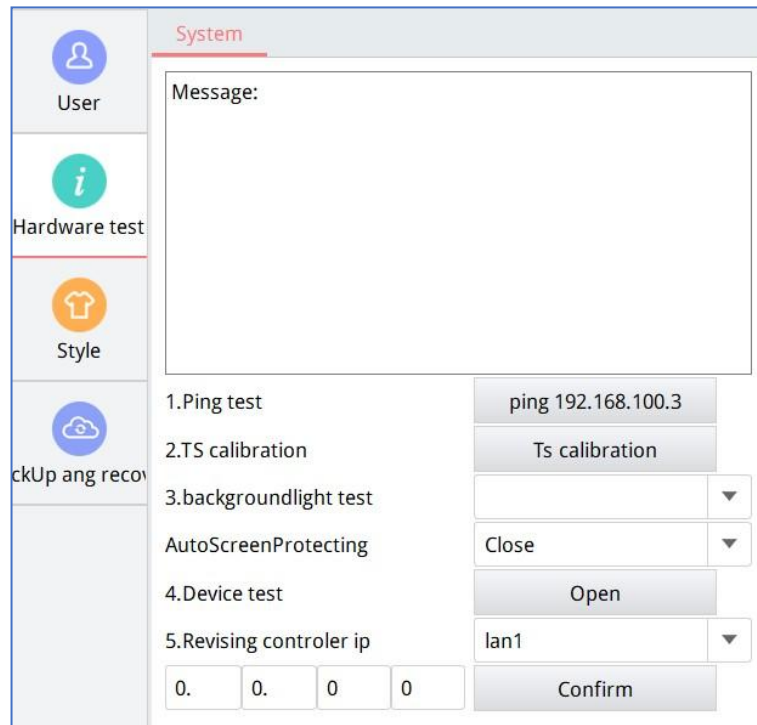

Figure 34 System version interface

List of parameters.

Serial number	Parameter Name	Parameter Description
1	Ping test	Check if the communication between the teach pendant and the controller is normal
2	Touch calibration	Calibrate the handheld touchscreen, and the handheld will automatically restart after the calibration procedure is executed.
3	Backlight Test	Adjust handheld lcd backlight brightness Automatic screensaver (on/off)
4	Handheld hardware testing	{open hardware test}
5	Modify the controller IP	Modify lan1,lan2 (lan3) network port IP